

2024

fetra[®]

●●●●

Transport equipment

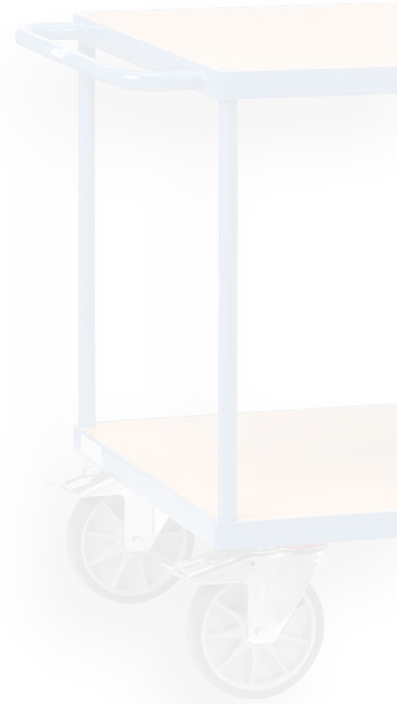

ROLLERS & LIGHT TROLLEYS • TROLLEYS • TRUCKS • WHEELS • LIFTING CARTS

➤	Introduction General facts about fetra / Quality features	2 – 10
➤	GREY EDITION A selection of topsellers in the trend colour antracite grey RAL 7016	11 – 20
➤	Rollers and light trolleys Dollies with gooseneck handles / Storeroom trolleys / Collapsible carts	21 – 29
➤	Trolleys MultiVario-Transporters / Table top carts / Workshop carts / Rolling desks / Shelved trolleys / Parcel carts	30 – 63
➤	ESD-Trolleys ESD-Trucks / ESD-Trolleys / ESD-Euro box carts	64 – 71
➤	Special trolleys Office trolleys / Box carts / Storeroom trolleys / Euro box carts / Super-MultiVario-Transporters / Trolleys with carrier spars / Sheet material transport	72 – 120
➤	Dump trucks Sheet metal dump trucks / Self-tilting boxes / Tipping containers	121 – 125
➤	Pallet transport Pallet dollies / Tugger train / Trolleys	126 – 131
➤	Hand carts Hand carts / Hand trucks	132 – 138
➤	Trucks Tubular steel trucks / Aluminium trucks / Stairway trucks / Compact hand trucks / Chair trucks / Trucks for appliances / Drum transport / Steel bottle trolleys	139 – 163
➤	Tyre transport Tyre trolleys / Tyre trucks	164 – 167
➤	Lifting carts Pallet trucks / Stackers / Lifting table carts / Machine lifters / Moving gears / Furniture lifting rollers / Angle rolls	168 – 178
➤	Wheels, Castors and Accessories Wheels / Swivel castors / Fixed wheel castors / Dead man brake / Electric drive unit / TOTALSTOP-central brake system / Platforms / Spare parts / Surcharge articles	178 – 186
➤	Index Keyword table	187

▶ **Table top carts with steel sheet**

in various versions



Page 37-38

▶ **ESD-Table top carts**

Platforms made of steel sheet flush and with rim



Page 67

▶ **Pallet dollies**

with polyurethane tyres



Page 127

▶ **Shelved trolleys**

with doors



Page 58

▶ **Compact hand truck "Wuppi"**

and accessories



Page 150

▶ **Wheels**

new wheels in exclusive fetra-design



Page 178-179



◀◀◀ fetra-Company film

► Quality made in Germany

fetra is a family-managed company that is clearly committed to the production site Germany. With a good feeling for engineering and material, we develop innovative transport devices in modern design. Our extensive range of more than 1,000 products reflects decades of manufacturing experience and is mostly all „Made in Germany“.



► Perfect workmanship guaranteed

fetra transport equipments are manufactured with highly efficient methods using the most advanced production facilities. Before they are powder-coated, all products undergo extensive pre-treatment by shot blasting. This environmentally friendly finish guarantees a long product lifecycle and permanent good looks. The result: Visibly perfect workmanship! We give you our word for it – and 10 years warranty on virtually all products!

► Excellent service and fast delivery

Perfect logistics! Our large warehouse and a sophisticated logistics system ensure short response times and fast delivery even in times of high workload. We are only satisfied once you are happy!



» fetra on the Web

Visit us on the Internet and find detailed information, products films, photos and PDF data sheets to download and forward. Discover useful services in our new log in area. Use this year's brand new chat function or just ask us questions and give us feedback! Go directly to www.fetra.com



» Catalogue Portal

All our printed documents in digital form. View catalogues, brochures and flyers as practical online flip documents or download them as PDF files. Collect single pages with the paperclip function and forward them. www.fetra.de/en/catalogue



» Media Library

Discover application films for several fetra products and watch our trucks and trolleys in action!

www.fetra.de/en/service/mediathek

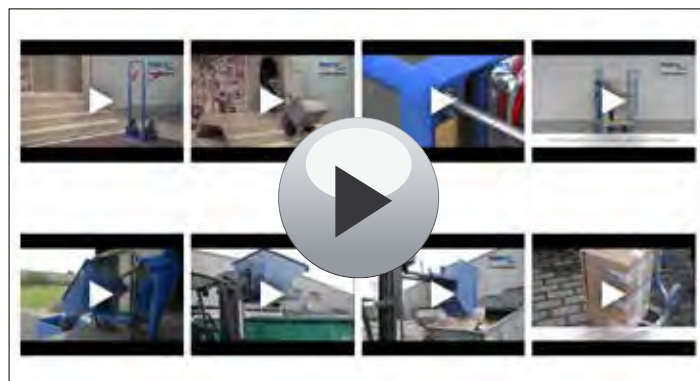

» Themed Worlds

Experience fetra products sorted by the needs of special target groups. See e.g. transport solutions for drum transport or the automotive sector at a glance in categories.

www.fetra.de/en/themedworlds



» Support and advice on Site

Our mission is to offer a solution for every in-house transport problem! Our factory-trained sales partner in your area will be glad to assist you!

www.fetra.de/en/sales-partners





Watch modular system film >>>

> Variety and functionality

Many fetra transport devices are available in a modular system. The system components are simply inserted and secured with bolts. This allows you to change, swop and add-on in many ways with the fetra MultiVario-System. Thanks to this fetra „Insert & Bolt Principle“ with 2-point support, the stability matches that of any welded structure!



> Platform sizes

Length x Width

Platform size: 850 x 500 mm

Platform size: 1.000 x 600 mm

Platform size: 1.000 x 700 mm

Platform size: 1.200 x 800 mm

> Wheels

Easy-running TPE-castors with groove ball bearing. Very low starting, rolling and swivelling resistance. Tyres non-marking = trackless. Low running noise on level floors.

> Construction

Tubular steel and sectional steel welded, stylish frame structure with „round edges“.

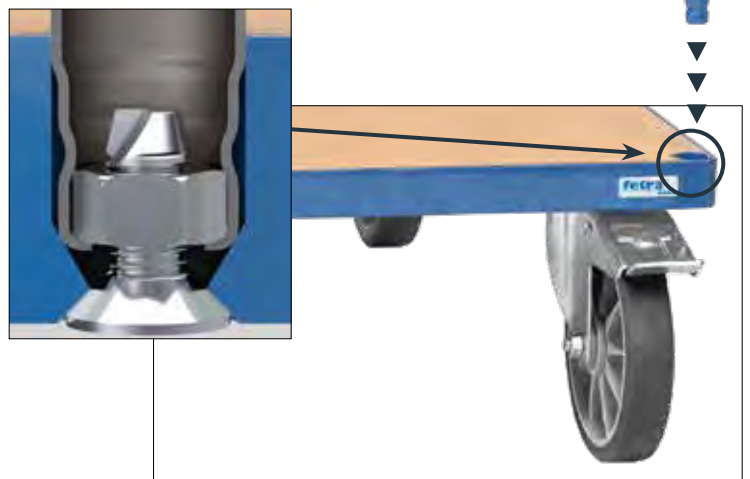

› Powder coating

The surface of our transport equipment is pretreated optimal by shot blasting. The elaborate procedure guarantees the perfect holding of the powder coating. The used quality powder is solvent-free and has a very high mechanical and chemical resisting. These high value finish guarantees long product lifecycle and permanent good looks.



› Versions

Different choices possible

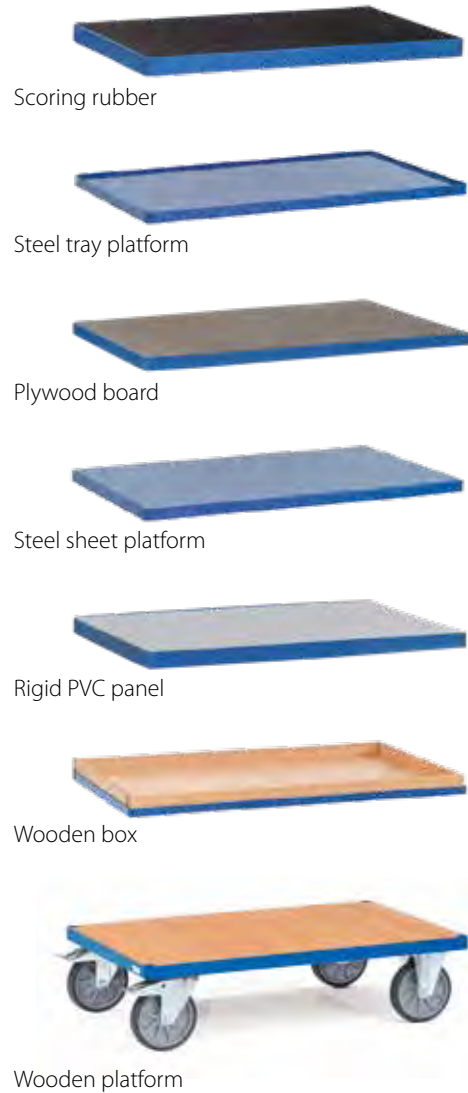

› Accessories

- Protective edge
- Protective wheels
- Clip board
- Wire basket
- Softgrip push handle
- Dead man brake
- Collapsible hinge
- Electric drive unit
- Waterproof platform
- Rigid PVC panel
- Scanner holder
- Waste collector
- Bottle holder
- Paper roll holder
- Shaft and tow hitch
- Alternativ wheel equipments
- And many more ...

› Side components

- Panelled end made of wood
- Panelled end made of wire mesh
- Push handle
- Stanchions
- And many more ...



▶ As standard equipment: the fetra – TPE castor

Wheels with TPE tyres (thermoplastic elastomer) have many benefits on level floors. The force required for transporting is minimised: with very little effort. Even heavy loads can be moved comfortably, safely and at low noise. The TPE castor with precision groove ball bearings in the appealing fetra design is compliant to EU regulation 1272/2013 PAH (Polycyclic Aromatic Hydrocarbon).



- ▶ **Very low starting, rolling and swivelling resistance**
- ▶ **Low noise operation on level floors**
- ▶ **Dark-grey tyre, dirt-resistant**
- ▶ **Tyres are non-marking, despite their dark colour (trackless)**
- ▶ **Maintenance-free groove ball bearing sealed on both sides**
- ▶ **PAH compliant to the EU regulation 1272/2013**
- ▶ **Thread protection prevents threads from wrapping around the wheel axle**
- ▶ **Appealing and individual fetra design**
(European design protection law © EU 00134689.4-001/00134689.4-003)



▶ TOTALSTOP – the fetra central brake system

Innovative, comfortable, ergonomic and safe: This brake system developed by fetra can be easily locked or released with only one foot. Apart from the rotation of the wheels, also the swivelling movement of both swivel castors is securely locked. This avoids hazardous situations by preventing the braked cart from swinging sideways. Due to its central location, the brake pedal is always visible to the operator and can be operated in any position of the castors. The rubber wheel locking device is effective on all tyre materials and can be very easily readjusted.



- ▶ **Innovative**
With only one push of the foot, the rotation of the wheel and swivelling movement of both swivel castors are blocked
- ▶ **Comfortable**
The brake pedal always remains in the operator's field of vision. Braking is possible in any position of the castors
- ▶ **Ergonomic**
Easy release of brake due to high ground clearance of pedal
- ▶ **Secure**
Wheel locking device made of rubber. Maximum braking performance on all tyre materials, easy to readjust
- ▶ **European patent EP 2743097**



Surcharge see page 183

For all transport trolleys marked with the TOTALSTOP logo.

FIXSTOP - the new fetra central directional locking

FIXSTOP is the particular comfortable directional locking by fetra. Instead of the 2 standard fixed-wheel castors 2 synchronous lockable swivel castors. The swivelling movements of both swivel castors can be fixed comfortable by operation of the central foot step bar from any longitudinal side in a grid of 4 x 90°. Thereby, with only one push of the foot the operator gets the choice between the manoeuvrability of a cart with 4 swivel castors and the directional stability of a cart with 2 swivel and 2 fixed-wheel castors. Operatable in any wheel position.

Surcharge per set for trolleys with TPE-tyres from 450 mm width.



- **Central operatable**
The FIXSTOP foot step bar can be operated from both longitudinal sides with only one push of the foot.
- **Flexible**
360° manoeuvrability and locking to fixed-wheel castor as needed.
- **Innovative**
Lean and modern design.
- **German patent 10 2016 110 300**



Foot step unlocked

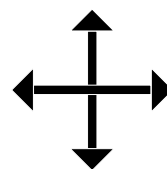

Foot step locked

Surcharge see page 184

For all transport trolleys marked with the FIXSTOP logo.

fetra-single directional locking device

The conventional directional locking system by fetra. Instead of the 2 standard fixed-wheel castors 2 individual lockable swivel castors. The swivelling movements of these swivel castors can be locked each individually from one longitudinal side each by operation of the fixed operating levers in a grid of 4 x 90°. Thereby, a good straight run in longitudinal and transverse direction becomes possible. Operatable in any wheel position.

Surcharge per set for trolleys with TPE-tyres.



- **Individually operatable**
Thereby, individual adjustable according to wish.
- **Flexible**
360° manoeuvrability and locking to fixed-wheel castor as needed.
- **Kick lever convertable**
Kick lever in standard lateral operatable. On reconstruction of the castor by 180° also operatable from the end side.
- **German patent 10 2016 110 300**

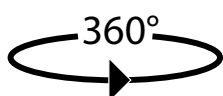

Operating lever unlocked

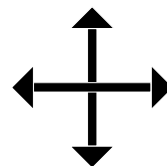

Operating lever locked

Surcharge see page 184



	TPE tyres	Polyamide wheels	Pneumatic tyres	Solid rubber tyres
Starting, rolling and swivelling resistance	Very low	Very low	Medium	Low
Running noise	Low on level floors	High on virtually all floors	Extremely low on all floors	Low on virtually all floors
Elasticity	Less smooth running	Inflexible hard running	Very smooth running	Smooth running
Sensitivity to soiling	Not sensitive	Very sensitive	Not sensitive	Not sensitive
Bearing	Part. smooth-running groove ball bearing	Smooth-running roller bearing	Smooth-running roller bearing	Smooth-running roller bearing
Capacity	For medium load capacities	For medium to high load capacities	For low to medium load capacities	For medium load capacities
Trackless	Non-marking (trackless)	Non-marking (trackless)	Optionally trackless tyres available	Optionally trackless tyres available
Floor characteristics	Suitable for level floors	Suitable for level floors	Suitable for level and slightly unlevel floors	Suitable for level and slightly unlevel floors
Conclusion	Cost-effective and easy-running wheel set for level floors; trackless even for sensitive flooring	Cost-effective wheel set with high load capacity, very low comfort; mostly resistant to moisture, salt, acidic and alkaline liquids	Ideal for poor ground conditions, in particular outdoors	Cost-effective wheel set for medium load capacities and universal usage
Cost	Standard wheel set – no surcharge see page 180	Surcharge on standard wheel set see page 184	Surcharge on standard wheel set see page 184	No longer available as standard



	Electrically conductive TPE tyres	Blue-grey solid rubber tyres	Polyurethane tyres	Elastic tyres
Starting, rolling and swivelling resistance	Very low	Low	Very low	Low
Running noise	Low on level floors	Low on virtually all floors	Low on virtually all floors	Extremely low on all floors
Elasticity	Less smooth running	Smooth running	Smooth running	Very smooth running
Sensitivity to soiling	Not sensitive	Very sensitive	Medium sensitive	Not sensitive
Bearing	Part. smooth-running groove ball bearing	Smooth-running roller bearing	Particularly smooth-running groove ball bearing	Particularly smooth-running groove ball bearing
Capacity	For medium load capacities	For medium load capacities	For high load capacities	For high load capacities
Trackless	Non-marking (trackless)	Non-marking (trackless)	Non-marking (trackless)	Non-marking (trackless)
Floor characteristics	Suitable for level floors	Suitable for level and slightly unlevel floors	Suitable for level and slightly unlevel floors	Suitable for level and slightly unlevel floors
Conclusion	Special wheel set for prevention of static charge	Cost-effective wheel set for medium load capacities; trackless even for sensitive flooring	Particularly high-quality and resistant wheel set for high load capacities; resistant against many aggressive materials	Highly comfortable due to easy, very smooth running; good for frequent crossing of edges and sills; high durability
Cost	Surcharge on standard wheel set see page 184	See page 181	Surcharge on standard wheel set see page 184	Surcharge on standard wheel set see page 184

What to consider?

A high-quality wheel set is essential for the successful application of a transport device according to its intended use. This is why fetra uses various tyres and bearings – depending on the ground, indoor and/or outdoor, transport weight or special requirements such as electrical conductivity, chemical resistance or wear characteristics.

fetra transport trolleys are standard-fitted with swivel castors and fixed-wheel castors with TPE tyres and groove ball bearings. Additionally, wheels and castors for virtually any field of use are available. Selecting the right option depends on the specific application, ground characteristics and transport weight.



Bush bearing

Simple and robust wheel bearing. Impact-resistant. Bushing made of polyamide. Corrosion-resistant, suitable for wet conditions. Under normal usage conditions maintenance-free. For devices with low speed and low usage intensity.



Roller bearing

Robust and durable wheel bearing. Impact-resistant. Low bearing friction. Permanent lubrication with long-life grease, under normal usage conditions maintenance-free. Well-proven bearing system for transport device castors.



Groove ball bearings

Highly robust precision wheel bearing. Impact-resistant. Very low bearing friction, permanent lubrication with long-life grease, mostly maintenance-free. Suitable for high load capacities and higher speeds.

GREY EDITION



Colouring:

fetra transport equipment in this colour combination fits perfectly into modern work environments. The powder coating in anthracite grey RAL 7016 is simple and timeless.



Platform:

The derived timber material boards in medium grey are insensitive to dirt and look particularly elegant matching the innovative fetra easy-running TPE-castors.



TPE castor:

The innovative easy-running TPE-castor in the attractive fetra design is non-marking and odourless. Particularly smooth-running groove ball bearing.





Dollies and collapsible carts

made of tubular steel welded and powder coated, anthracite grey RAL 7016, with tubular steel, sheet wooden platform, handles bolted on, 2 swivel and 2 fixed-wheel castors, TPE tyres, hubs groove ball bearing.

Swivel castors with wheel locks.

1161/7016*

Platform made of derived timber material boards housed in the frames, surface grey.

1164/7016

Dollies made of tubular steel welded and powder coated, anthracite grey RAL 7016, with platform made of wooden, handles bolted on.

Capacity upper shelf 100 kg.

1132/7016 | 1154/7016

Handlebar foldable onto platform.

Loading height with wheel-Ø 125 mm: 205 mm
wheel-Ø 160 mm: 230 mm

1200/7016 | 1202/7016

Loading height with wheel-Ø 125 mm: 206 mm

**Open Carts
Modular system**

2500/7016 - 2503/7016

Tubular steel and profile steel welded, powder coated, surface durably protected, resistant to impact and scratches. Platform made of derived timber material boards, surface grey.

2 swivel and 2 fixed-wheel castors, TPE tyres, 160 x 40 or 200 x 40 mm, hubs with groove ball bearing or pneumatic tyres 220 x 70 mm (additional charge).

Swivel castors with wheel locks.

Height of loading platform:

TPE 160 Ø = 228 mm

TPE 200 Ø = 270 mm

Pneumatic tyres 220 Ø = 285 mm

*Can not be fitted with TOTALSTOP.

**Accessories
on pages 183-185**



1161/7016*



1164/7016



1132/7016 | 1154/7016



1200/7016 | 1202/7016



2500/7016 - 2503/7016

	Order no.	Capacity kg	Wheel-Ø mm	Platform size L x W mm	Outside dimensions L x W x H mm	Net weight kg	
Dollies	1161/7016*	250	125	600 x 500	890 x 500 x 860	11	
	1164/7016	250	125	600 x 450	860 x 450 x 875	19	
Collapsible carts	1132/7016	250	125	720 x 450	815 x 470 x 930	15	
	1154/7016	250	160	900 x 600	995 x 620 x 965	24	
Storeroom trolleys	1200/7016	250	125	850 x 450	1100 x 450 x 910	15	
	1202/7016	250	125	1000 x 600	1250 x 600 x 910	19	
Open carts	2500/7016	500	160	850 x 500	975 x 509 x 948	23	
	2501/7016	600	200	1000 x 600	1125 x 609 x 990	27	
	2502/7016	600	200	1000 x 700	1125 x 709 x 990	30	
	2503/7016	600	200	1200 x 800	1325 x 809 x 990	35	



Light table top carts

2740/7016 | 2742/7016
2750/7016 | 2752/7016

Table top carts, tubular steel welded and powder coated anthracite grey RAL 7016, surface durably protected, resistant to impact and scratches, shelves made of derived timber material boards, in a frame of angle steel, height of rim 12 mm, with a high push bar.

2 swivel and 2 fixed-wheel castors with TPE tyres, hubs with groove ball bearing.

Swivel castors with wheel locks.

Capacity upper and middle shelf 80 kg.

Table top carts with trays

4820/7016 | 4822/7016
4830/7016 | 4832/7016

Table top cart, steel construction, welded. Tubular steel hoop and steel plate trays screwed. Trays oil-tight, rim 40 mm high, powder coated anthracite grey RAL 7016.

2 swivel and 2 fixed-wheel castors with TPE tyres, hubs with groove ball bearing.

Swivel castors with wheel locks.

Capacity upper and middle shelf 200 kg.



Tablet holder
For details see page 185.



Scanner holder
For details see page 185.



	Order-Nr.	Capacity kg	Wheel-Ø mm	Platform size L x W mm	Outside dimensions L x W x H mm	Shelf heights mm	Net weight kg
Table top carts	2740/7016	300	125	850 x 500	986 x 511 x 1039	200, 820	28
	2742/7016	300	125	1000 x 600	1136 x 611 x 1039	200, 820	36
	2750/7016	300	125	850 x 500	986 x 511 x 1039	200, 510, 820	35
	2752/7016	300	125	1000 x 600	1136 x 611 x 1039	200, 510, 820	49
Table top carts with trays	4820/7016	400	160	850 x 500	1021 x 500 x 870	207, 829	36
	4822/7016	400	200	1000 x 700	1171 x 700 x 910	248, 870	47
	4830/7016	400	160	850 x 500	1021 x 500 x 870	207, 519, 829	46
	4832/7016	400	200	1000 x 700	1171 x 700 x 910	248, 560, 870	61

Accessories
on pages 183-185



MultiVario- Heavy table top carts Modular System

Tubular steel and sectional steel, welded and powdercoated, surface durably protected, resistant to impact and scratches, shelves made of derived timber material boards, surface grey. 2 swivel and 2 fixed-wheel castors with TPE tyres 160 x 40 mm resp. 200 x 40 mm.

Swivel castors with wheel locks.

2496/7016

Square platforms
600 x 600 mm.

2 shelves

Capacity upper platform
200 kg.

2416/7016

as 2496/7016, but with 3
shelves.

Capacity upper and middle
shelf 200 kg.

2400/7016 - 2403/7016

as 2496/7016, but rectangular
platforms in 4 sizes.

Super-MultiVario Heavy table top carts

is especially designed for heavy loads. High-quality elasticated solid-rubber wheels and hubs with ball bearings guarantee an extreme manoeuvrability and a smooth run. Steel tube and sectional steel welded, powder coated, grey RAL 7016. Platforms made of antislip waterproof plywood boards (insert type of board). 2 swivel and 2 fixed-wheel castors, elasticated solid rubber tyres 200 x 50 mm, blue-grey „trackless“ hubs with ball bearings.

12497/7016

Square platforms
700 x 700 mm.

2 shelves

Capacity upper platform
500 kg.

12402/7016 - 12406/7016

as 12497/7016, but rectangular
platforms in 4 sizes.

*Can not be fitted with
FIXSTOP.

**Accessories
on pages 183-185**



2496/7016



2416/7016



2400/7016 - 2403/7016



12497/7016*



12402/7016 - 12406/7016*

	Order no.	Capacity kg	Wheel-Ø mm	Platform size L x W mm	Outside dimensions L x W x H mm	Shelf heights mm	Net weight kg
Table top carts	2496/7016	500	160	600 x 600	737 x 609 x 860	228, 860	32
	2416/7016	500	160	600 x 600	737 x 609 x 860	228, 544, 860	44
	2400/7016	500	160	850 x 500	1047 x 509 x 860	228, 860	36
	2401/7016	600	200	1000 x 600	1197 x 609 x 900	270, 900	44
	2402/7016	600	200	1000 x 700	1197 x 709 x 900	270, 900	49
	2403/7016	600	200	1200 x 800	1397 x 809 x 900	270, 900	58
Table top carts	12497/7016*	1200	200	700 x 700	910 x 700 x 925	283, 925	54
	12402/7016*	1200	200	1000 x 700	1210 x 700 x 925	283, 925	67
	12403/7016*	1200	200	1200 x 800	1410 x 800 x 925	283, 925	77
	12405/7016*	1200	200	1600 x 800	1810 x 800 x 925	283, 925	100
	12406/7016*	1200	200	2000 x 800	2210 x 800 x 925	283, 925	156



2450/7016



12450/7016



2452/7016



12452/7016



2456/7016



12456/7016



Drawer subdivision-set

made of galvanized steel sheet, insertable. 1 longitudinal partition and 4 dividing sheets.

Workshop carts

Steel construction.
 Worktop composite panel 20 mm.
 2 swivel and 2 fixed-wheel castors, TPE tyres 160 x 40 mm, swivel castors wheels with lock.
 Powder coated, carcass grey RAL 7035, front anthracite grey RAL 7016.
 For technical reasons relating to transport the working platform the worktop and the wheels are not mounted. Easy self assembly.
 Capacity per shelf 80 kg.

2450/7016

With 1 cupboard, 1 fixed and 2 adjustable shelves, and drawers with ball bearing slide. Centrally lockable by cylinder lock.
 6 drawers
 H x W x D: 95 x 280 x 470 mm
 Capacity per drawer 35 kg.

2452/7016

With 1 cupboard, 1 fixed and 2 adjustable shelves, and drawers with ball bearing slide. Centrally lockable by cylinder lock.

4 drawers
 H x W x D
 1 pc. 105 x 280 x 470 mm
 2 pcs. 160 x 280 x 470 mm
 1 pc. 210 x 280 x 470 mm
 Capacity per drawer 35 kg.

2456/7016

With 1 cupboard with double door without separation wall. 2 adjustable shelves. Doors centrally lockable by cylinder lock. Maximum opening angle 120°. Useful depth: 873 mm Useful width: 465 mm Opening width: 784 mm

12450/7016 | 12452/7016 | 12456/7016

Workshop carts with skirting on three sides 80 mm high, made of powder coated steel sheet.

	Order no.	Capacity kg	Wheel-Ø mm	Platform size L x W mm	Outside dimensions L x W x H mm	Net weight kg
Workshop carts	2450/7016	400	160	985 x 590	1080 x 590 x 915	66
	2452/7016	400	160	985 x 590	1080 x 590 x 915	62
	2456/7016	400	160	985 x 590	1080 x 590 x 915	48
Workshop carts with skirting	12450/7016	400	160	985 x 590	1080 x 590 x 995	71
	12452/7016	400	160	985 x 590	1080 x 590 x 995	67
	12456/7016	400	160	985 x 590	1080 x 590 x 995	53
Drawer subdivison set	2146	-	-	-	-	-



Pallet Dollies

For pallets and lattice boxes. Sturdy sectional steel construction with 4 catch corners for stacking, powder coated, anthracite grey RAL 7016. 2 swivel and 2 fixed-wheel castors. Castors with wheel lock.

22801/7016

Capacity 750 kg

TPE tyres 200 x 40 mm, hubs with ball bearings. Very low starting, rolling and swivelling resistance. Tyres are non-marking (trackless). Low-noise running on even flooring.



22801/7016



22881/7016

22881/7016

Capacity 1050 kg

Polyamide wheels 200 x 50 mm, hubs with roller bearings. Low rolling resistance, high chemical resistance, non marking. Road noise.



22881/7016



23891/7016 | 23892/7016

22811/7016

Capacity 1200 kg

Elasticated solid rubber tyres 200 x 50 mm, blue-grey „trackless“, hubs with ball bearings. Low rolling resistance, easy movement, no road noise.

Trolleys for standard tugger trains

23891/7016

23892/7016

Capacity 1050 kg

Suitable for transport on standard tugger trains. Resilient angle steel design with corners supports.

Powder coated in anthracite grey RAL 7016. swivel castors with polyamide wheels 200 x 50 mm white, but 1 castor is electrically conductive, black polypropylene wheel body, hub with precision ball bearings. 2 swivel castors with full locking device in the lead diagonal layout.

Ground clearance: 235 mm



23990



23991

Extra charge for 1 swivel castor with directional locking device instead of 1 swivel castor without locking device.

4 x 90° degrees locking provides good directional stability in longitudinal and transversal direction. Fixed operating lever underneath the frame, not protruding. To be operated from the long side. Easy reach in any castor position.

German patent 10 2016 110 300.4

Special equipment for 23891/7016 and 23892/7016.

Extra charge for 2 swivel castors with fixed locking device operating levers instead of the swivel castors with pivoting operating levers.

Fixed operating levers underneath the frame, not protruding. To be operated from the long side. Easy reach in any castor position. Ground clearance increased to 237 mm, overall height to 282 mm.

Special equipment for 23891/7016 and 23892/7016.

	Order no.	Capacity kg	Platform size L x W mm	For pallet size L x W mm	Outside dimensions L x W x H mm	Loading height mm	Net weight kg	
Pallet Dollies	22801/7016	750	1210 x 810	1200 x 800	1255 x 855 x 329	282	34	
	22881/7016	1050	1210 x 810	1200 x 800	1255 x 855 x 329	282	33	
	22811/7016	1200	1210 x 810	1200 x 800	1255 x 855 x 329	282	35	
Trolleys for standard tugger trains	23891/7016	1050	1210 x 810	1200 x 800	1255 x 855 x 327	280	34	
	23892/7016	1050	1210 x 1010	1200 x 1000	1255 x 1055 x 327	280	34	
	23990		1 swivel castor with directional locking device					
	23991		2 swivel castors with fixed locking device operating levers					



22921/7016

Stacking frames for pallet dollies

22921/7016

For parking flat pallets and pallet cages at an ergonomically comfortable level. Angle steel construction with catch corners, sturdy tubular supports with base plates. Stable support tubes with foot plates, to be inserted into corner sleeves at the stacking frame. Powder coated, anthracite grey RAL 7016.

Stacking frames can be bolted tight with the pallet dolly via base plates and bolting set (included in delivery).



22892/7016

Self-locking push handle 22892/7016

Self-locking push handle for pallet dollies from 800 mm width. For comfortable and ergonomic moving of empty and loaded pallet dollies. Sturdy tubular steel construction with strong support claws. Handle and cross tube with softgrip. In unlocked position movable via two auxiliary rollers.

Utility patent
20 2014 010 367



Example of use

Order no.	Capacity kg	Platform size L x W mm	For pallet size L x W mm	Height mm		Net weight kg
				without pallet dolly	with pallet dolly	
22921/7016	1200	1210 x 810	1200 x 800	370	652	19
22892/7016			Self-locking push handle			7,5



Mobile tilting stands

3270/7016

For plastic boxes, steel plate boxes, wire baskets etc., adjustable in height and mobile. Sectional steel-/ tubular construction with steelplate platform. Powder coated anthracite grey RAL 7016. 4 swivel castors with TPE tyres, hubs with bush bearing, 2 wheels with locks.

Steel plate platform with all side rim, 20 mm high. Not inclinable, adjustable in height in intervals of 25mm.

Height adjustable from 720 - 995 mm.



3270/7016



13580/7016

Euro box rollers

Compatible for Euro boxes 600 x 400 mm, powder coated anthracite grey RAL 7016. 4 swivel castors with TPE tyres, hubs with groove ball bearing. 2 wheels with locks. Flat packed delivery.

13580/7016

Open angle steel construction.



13540/7016



135400/7016

13540/7016

Roller with 2 platforms. Both platforms of derived timber material board housed in frames, rim 15 mm high. Clearance between platforms 400 mm. Loading height 194/623 mm. Capacity of upper shelf 100 kg.

135400/7016

as 13540/7016, but with tubular push bar. Loading height 194/623 mm.



1384/7016

1384/7016

Euro box cart, tubular and sectional steel construction, bolted. Variable use of shelf frames, distance 100 mm, angle when inclined 15° and 30°. Shelf heights: 311, 611, 911, 1211, 1511 mm. Capacity per shelf 80 kg.

With 5 platforms made of derived timber material boards, rim 13 mm high.

	Order no.	Capacity kg	Wheel-Ø mm	Platform size L x W mm	Outside dimensions L x W x H mm	Net weight kg
Mobile tilting stands	3270/7016	150	75	605 x 405	605 x 405 x 995	17
Euro box rollers	13580/7016	250	125	605 x 405	605 x 405 x 209	9
	13540/7016	250	125	605 x 408	677 x 414 x 638	17
	135400/7016	250	125	605 x 408	747 x 414 x 970	18
Euro box cart	1384/7016	400	160	1240 x 610	1372 x 685 x 1686	109



8301/7016 - 8303/7016



Reinforcement struts increases the capacity of inserted shelves.



Shelved trolleys | box carts

Tubular and sectional steel or angle steel, welded and powder coated anthracite grey RAL 7016. 1 fix and 3 or 4 shelves made of special wood material boards, surface grey. Variable use of shelves, in a grid of 100 mm. Capacity per shelf 90 kg. 2 swivel and 2 fixed-wheel castors, TPE tyres 200 x 40 mm, hubs with groove ball bearing.

Shelved trolleys Modular system

8301/7016 - 8303/7016

Bolted construction. Swivel castors with wheel locks.

Shelves

Additional charge or price reduction for shelves including 1 pair of support brackets.

Size mm	Order no.
1000 x 600	E8101ETAW/7016
1000 x 700	E8102ETAW/7016
1200 x 800	E8103ETAW/7016

Reinforcement struts for shelved trolleys

With flanges for two-point screw attachment. 1 pair per trolley is included. Capacity per shelf is 150 kg instead of 90 kg.

If more shelves need to have an increased capacity, please order reinforcement struts correspondingly.

Reinforcement struts 1 additional pair for 1 shelf

Size mm	Order no.
1000 x 600	E8101VK/7016
1000 x 700	E8102VK/7016
1200 x 800	E8103VK/7016



5392/7016 - 5393/7016



Vertical locking rod with turning lever and cylinder lock.



TOTALSTOP - the fetra central brake system
With only one foot the rotation of wheels and the swivelling movement of both swivel castors can be securely locked. The brake pedal is always visible to the operator. Standard with TOTALSTOP.



Box carts 5392/7016 | 5393/7016

in angle steel construction with tubular handlebar and with 2-leaf door of angle steel with welded wire lattice. Delivery includes 4 shelves. Wire lattice 40 x 40 x 4 mm, completely welded and powder coated anthracite grey RAL 7016.

1 fixed and 4 detachable wood material shelves, surface grey. 2 swivel and 2 fixed-wheel castors with TPE tyres, hubs with groove ball bearing.

Accessories on pages 183-185

	Order no.	Capacity kg	Platform size L x W mm	Outside dimensions L x W x H mm	Shelf heights mm	Net weight kg
Shelved trolleys	8301/7016	600	1000 x 600	1169 x 609 x 1800	269, 669, 1069, 1469	64
	8302/7016	600	1000 x 700	1169 x 709 x 1800	269, 669, 1069, 1469	69
	8303/7016	600	1200 x 800	1369 x 809 x 1800	269, 669, 1069, 1469	86
Box carts	5392/7016	750	1000 x 680	1170 x 745 x 1792	292, 582, 882, 1182, 1482	144
	5393/7016	750	1200 x 780	1370 x 845 x 1792	292, 582, 882, 1182, 1482	175
Add. shelves	1325/7016			for Box cart 5392/7016		
	1926/7016			for Box cart 5393/7016		

Tubular steel truck B1330L/7016

Handy tubular steel truck with steel sheet blades, sturdy welded construction, anthracite grey RAL 7016. Safety grips. Steel sheet front shovel mountable, therefore exchangeable. Pneumatic tyres on synthetic rims, hubs with roller bearings. Curved top bar and transversal struts. For safe transport of circular items such as rolls, cans, buckets etc.

With replaceable synthetic rockers.

Flat packed delivery.

Utility patent

20 2004 010 071.1



B1330L/7016

	Order no.	Capacity kg	Height mm	Blade length mm	Blade width mm	Total width mm	Pneumatic tyres mm	Net weight kg
Tubular steel truck	B1330L/7016	300	1300	250	320	580	260 x 85	15

➤ Further devices in anthracite grey can be found on the following pages:

➤ Sheet metal dump trucks



Page 121-123

➤ Lifting table carts



Page 171-173

➤ Angle rolls



Page 177

DOLLIES WITH GOOSENECK HANDLES

Handle:

One-hand operation for swift transport of small items up to 250 kg.



Platform:

Loading platform made of wood, optionally also available with steel sheet.



TPE castor:

The innovative easy-running TPE-castor in the attractive fetra design is non-marking and odourless. Particularly smooth-running groove ball bearing.



Field of application:

Easy to handle and manoeuvrable, even in narrow aisles. Ideal for boxes and crates.



Dollies with gooseneck handles

made of tubular steel welded and powder coated, blue RAL 5007, with tubular steel, sheet steel or wooden platform, handles bolted on, 1 respectively 2 swivel and 2 fixed-wheel castors 125 x 32 mm. Wheels with TPE tyres, hubs with precision deep groove ball bearing.

Swivel castors with wheel locks.

1158* | 1161*

Platform made of derived timber material boards housed in the frames, surface beech grain.

1163*

Platform made of sheet steel, flush with frame, steel sheet 2 mm thick, powder coated.

2167*

with detachable plastic box 600 x 400 x 220 mm. Frame made of angular steel, 610 x 410 mm, without wooden platform. Shaft with bolt connection, powder coated blue RAL 5007.

1164

with platform made of wooden, handles bolted on. Capacity upper shelf 100 kg.

1197

with 2 sheet steel platforms, flush with frames, steel sheet 2 mm thick, powder coated.

* Can not be fitted with TOTALSTOP.



1158*



1161*



1163*



2167*



1164



1197

	Order no.	Capacity kg	Platform size L x W mm	Outside dimensions L x W x H mm	Shelf heights mm	Net weight kg	
Dollies with gooseneck handles	1158*	200	600 x 450	860 x 450 x 860	195	10	
	1161*	250	600 x 500	890 x 500 x 860	195	12	
	1163*	250	600 x 500	890 x 500 x 860	195	14	
	2167*	250	610 x 410	890 x 410 x 860	209	13	
	1164	250	600 x 450	860 x 450 x 875	195, 770	19	
	1197	250	600 x 450	860 x 450 x 875	195, 770	21	



1165



1166 | 1169 | 1170



2166 | 2173 | 2174



1167



1187



1168

Dollies

made of angular steel, welded, powder coated, blue RAL 5007, 4 swivel castors with TPE tyres, hubs with precision deep groove ball bearing.
2 swivel castors with wheel locks.

1165
with open frame.

1166 | 1169 | 1170
with wooden platform.

2166 | 2173 | 2174
with wooden platform covered with corrugated rubber.

1167
with chequer plate platform.

1187
with aluminium platform with ribbed structure.

1168
with cradle for reels, bales etc.

	Order no.	Capacity kg	Wheel-Ø mm	Platform size L x W mm	Outside dimensions L x W x H mm	Shelf heights mm	Net weight kg
Small dollies	1165	400	125	500 x 500	500 x 500 x 183	183	11
	1166	400	125	500 x 500	500 x 500 x 199	199	13
	1169	400	125	600 x 600	600 x 600 x 199	199	16
	1170	400	125	700 x 700	700 x 700 x 199	199	19
	2166	400	125	500 x 500	500 x 500 x 201	201	14
	2173	400	125	600 x 600	600 x 600 x 201	201	17
	2174	400	125	700 x 700	700 x 700 x 201	201	20
	1167	400	125	500 x 500	500 x 500 x 185	185	14,5
	1187	250	125	500 x 500	500 x 500 x 184	184	9
Bale cradle dolly	1168	400	125	500 x 500	500 x 500 x 288	288	13

Accessories
on pages 183-185

STOREROOM TROLLEYS



Pleasant and light:
For fast transport up to 400 kg.

TPE castor:
The innovative easy-running TPE-castor in the attractive fetra design is non-marking and odourless. Particularly smooth-running groove ball bearing.



Large variety:
Handy trolleys for the quick transport of small loads.



Storeroom trolleys

1200 | 1202 | 2100 | 2102

Tubular steel, welded construction, powder coated, blue RAL 5007. Platform made of derived timber material board, beech decor surface.

2 swivel and 2 fixed-wheel castors, TPE tyres, hubs groove ball bearing. Swivel castors with wheel locks.

Loading height with wheel Ø of 125 mm: 206 mm
wheel Ø of 160 mm: 233 mm

Table top carts

Modular system, platform and pushbar with screw connection, upper shelves can be inserted. Disassembled on delivery. Welded tubular or sectional steel construction, powder coated, blue RAL 5007. Shelves made of derived timber material board, beech decor surface.

2 swivel and 2 fixed-wheel castors, TPE tyres, hubs groove ball bearing. Swivel castors with wheel locks.

1600 | 1602

Shelf heights: 209/826 mm
Capacity upper shelf 80 kg.

1800 | 1802

Construction as above, but with 3 shelves.

Shelf heights: 209/515/826 mm

Capacity upper and middle shelf 80 kg.

2600 | 2602

Top shelves with screw connection.
Height of shelves 233/736 mm
Capacity upper shelf 120 kg.

2610 | 2612

Construction as above, but with 3 shelves.

Shelf heights with 233/485/736 mm

Capacity upper and middle shelf 120 kg.

Accessories
on pages 183-185

	Order no.	Capacity kg	Wheel-Ø mm	Platform size L x W mm	Outside dimensions L x W x H mm	Net weight kg
Storeroom trolleys	1200	250	125	850 x 450	1100 x 450 x 910	14
	1202	250	125	1000 x 600	1250 x 600 x 910	19
	2100	400	160	850 x 500	1030 x 505 x 953	21
	2102	400	160	1000 x 700	1180 x 705 x 953	29
Table top carts	1600	200	125	850 x 500	1030 x 500 x 1020	25
	1602	200	125	1000 x 600	1180 x 600 x 1020	28
	1800	200	125	850 x 500	1030 x 500 x 1020	34
	1802	200	125	1000 x 600	1180 x 600 x 1020	40
	2600	400	160	850 x 500	970 x 505 x 968	29
	2602	400	160	1000 x 700	1120 x 705 x 968	41
	2610	400	160	850 x 500	970 x 505 x 968	36
	2612	400	160	1000 x 700	1120 x 705 x 968	51

Aluminium platform trolley 3120

with foldable tubular push handle, closed platform with anti-slip surface, sturdy rounded edge profiles. Tubular push handle with wide strut and sturdy hinged mounting. 2 swivel and 2 fixed-wheel castors, solid rubber tyres, hubs with plain bearing. Swivel castors with wheel locks. Flat packed delivery.



3120



3100 | 3101

All-Steel trolleys 3100 | 3101

Shelves made of pressed steel plate, powder coated blue RAL 5007, with adhered anti-slip covering and all round protective strip. Foldable tubular push handle, with wide cross strut, powder coated, finished bright galvanized. 2 swivel and 2 fixed-wheel castors. Swivel castors with wheel locks. Hubs with plain bearing. Flat packed delivery.



3112



3113

3112 | 3113

Table top cart with 2 or 3 shelves. Fixed tubular push handle, bright galvanized.

Shelf heights:

3112 = 140/655 mm

3113 = 140/390/655 mm

Capacity upper and middle shelf 60 kg.



3130



3132

Plastic platform trolley

Platforms made of plastic with anti-slip surface. In blue colour. Tubular push handle. 2 swivel and 2 fixed-wheel castors, solid rubber tyres, hubs with plain bearing. Flat packed delivery.

3130

Foldable tubular push handle, with wide cross strut and finished bright galvanized.

3132

Table top cart with 2 shelves, tubular push handle, fixed, bright galvanized.

Shelf heights: 175/715 mm

Capacity upper and middle shelf 80 kg.

Accessories on pages 183-185 are not available for the trolleys on this page.

	Order no.	Capacity kg	Wheel-Ø mm	Platform size L x W mm	Outside dimensions L x W x H mm	Net weight kg	
Alu platform trolley	3120	150	100	740 x 480	760 x 495 x 885	10	
All-steel trolleys	3100	150	100	740 x 480	760 x 495 x 860	12,2	
	3101	250	125	910 x 610	920 x 630 x 890	18,3	
	3112	120	100	740 x 480	760 x 495 x 860	18	
	3113	120	100	740 x 480	760 x 495 x 860	22,7	
Plastic platform trolley	3130	200	125	810 x 500	815 x 540 x 890	13	
	3132	200	125	810 x 500	815 x 540 x 890	16,7	

COLLAPSIBLE CARTS



Folding mechanism:
Easy and quick operatable by foot.
Ready to use in a few seconds.



Versions:
Available in steel and aluminium
version.



Compact:
Space saving to store and therefore
ideal on the go.





**Collapsible carts
1132 | 1154**

Tubular steel cart, powder coated, with platform made of derived timber material boards. Surface beech grain. Handlebar folds onto platform.

2 swivel and 2 fixed-wheel castors, TPE tyres, hubs groove ball bearing. Swivel castors with wheel locks.

Loading height with wheel Ø of 125 mm: 205 mm
wheel Ø of 160 mm: 230 mm

1133 | 1134

as 1132 | 1154, but tubular aluminium cart with aluminium platform.

1140 | 1141

as 1132 | 1154, but with 2 handlebars foldable onto platform. Foldable table platform made of steel tube, platform made of derived timber material boards.

Shelf heights:

1140 = 205/860 mm

1141 = 230/885 mm

Capacity upper platform 80 kg.

German Patent 100 62 425

1180 | 1181

as 1140 | 1141, but tubular aluminium cart with aluminium platforms.



1132 | 1154



1140 | 1141



1133 | 1134



1180 | 1181

	Order no.	Capacity kg	Wheel-Ø mm	Platform size L x W mm	Outside dimensions L x W x H mm	Net weight kg	
Collapsible carts	1132	250	125	720 x 450	815 x 470 x 930	16	
	1154	250	160	900 x 600	995 x 620 x 965	25	
	1133	200	125	720 x 450	815 x 470 x 930	11	
	1134	200	160	900 x 600	995 x 620 x 965	18	
	1140	250	125	720 x 450	900 x 470 x 900	26	
	1141	250	160	900 x 600	1080 x 620 x 930	40	
	1180	200	125	720 x 450	900 x 470 x 900	18	
	1181	200	160	900 x 600	1080 x 620 x 930	27	

Accessories
on pages 183-185



2500-K | 2501-K | 2502-K | 2503-K

Collapsible carts
2500-K | 2501-K |
2502-K | 2503-K

Tubular steel and profile steel welded, powder coated, with platform made of derived timber material boards. Surface beech grain. Handlebar foldable onto platform. 2 swivel and 2 fixed-wheel castors, TPE tyres, hubs with groove ball bearing. Swivel castors with wheel locks.

Optiliner

This ideal handle is the ergonomic alternative to the classical pushbar.

Construction as collapsible cart 1132, but with red derived timber material boards surface.

3301

Loading height: 230 mm
 total height hinged: 355 mm

3601

as Optiliner but without hinged grip.
 Shelf heights: 230/735 mm
 Capacity upper shelf 200 kg.



3301



3601



Optiliner handle
 Ergonomic handle for a better pushing comfort.

	Order no.	Capacity kg	Wheel-Ø mm	Platform size L x W mm	Outside dimensions L x W x H mm	Net weight kg
Collapsible carts	2500-K	500	160	850 x 500	907 x 509 x 1057	24
	2501-K	600	200	1000 x 600	1120 x 609 x 1099	28
	2502-K	600	200	1000 x 700	1120 x 709 x 1099	32
	2503-K	600	200	1200 x 800	1325 x 809 x 1099	37
Optiliner	3301	400	160	900 x 600	1010 x 620 x 1030	25
	3601	400	160	900 x 600	1115 x 600 x 1030	34

Accessories
 on pages 183-185

MULTIVARIO-CARTS



Modular system:

Multi-functional modular system with the proven fetra „Insert & Bolt Principle“. MultiVario transport carts can be changed, swapped and added-on in many ways.



MultiVario:

The system components are simply inserted and secured with bolts.



TPE castor:

The innovative easy-running TPE-castor in the attractive fetra design is non-marking and odourless. Particularly smooth-running groove ball bearing.



Elegance:

Stylish frame construction of one cast with round edges.



**MultiVario-Transporter
Modular system**

The MultiVario-Transporter can be altered, interchanged and supplemented in many ways. The system components are simply inserted into the basic element 2590-2593 and bolted tight.

Tubular steel and profile steel welded, powder coated, surface durably protected, resistant to impact and scratches. Platform made of derived timber material boards, surface beech design.

2 swivel and 2 fixed-wheel castors, TPE tyres, 160 x 40 or 200 x 40 mm, hubs with groove ball bearing.

Swivel castors with wheel locks.

Height of loading platform:

TPE 160 Ø = 228 mm

TPE 200 Ø = 270 mm

Pneumatic tyres 220 Ø = 285 mm

Open carts

2500B - 2503B

Platform made of sheet steel, flush with frame, welded, powder coated RAL 5007.

**Stanchioned trolleys
2580 - 2583**

Stanchions 693/640 mm long

Accessories MultiVario

- Different tyres
- 4 swivel castors
- Protective edge
- Protective wheels
- Clip board and wire basket
- Softgrip push handle
- Dead man brake
- Collapsible push handle
- Electric drive unit
- Scanner holder
- Waterproof platforms
- PVC panel
- Scoring rubber
- Tablet holder
- Bottle holder
- Paper roll holder
- Waste collector
- Storage tray
- Directional locking

**Accessories
on pages 183-185**



MultiVario
Insert-and-Bolt Principle



**Waterproof and more
platforms**
for MultiVario transporters
(for details see page 184)

	Order no.	Capacity kg	Wheel-Ø mm	Platform size L x W mm	Outside dimensions L x W x H mm	Net weight kg
Open carts	2500	500	160	850 x 500	975 x 509 x 948	23
	2501	600	200	1000 x 600	1125 x 609 x 990	27
	2502	600	200	1000 x 700	1125 x 709 x 990	30
	2503	600	200	1200 x 800	1325 x 809 x 990	35
Open carts with platform made of sheet steel	2500B	500	160	850 x 500	975 x 509 x 948	28
	2501B	600	200	1000 x 600	1125 x 609 x 990	32
	2502B	600	200	1000 x 700	1125 x 709 x 990	34
	2503B	600	200	1200 x 800	1325 x 809 x 990	42
Stanchioned trolleys	2580	500	160	850 x 500	1100 x 509 x 923	24
	2581	600	200	1000 x 600	1250 x 609 x 960	29
	2582	600	200	1000 x 700	1250 x 709 x 960	32
	2583	600	200	1200 x 800	1450 x 809 x 960	37
Platform trolleys	2590	500	160	850 x 500	919 x 509 x 228	22
	2591	600	200	1000 x 600	1069 x 609 x 270	26
	2592	600	200	1000 x 700	1069 x 709 x 270	27
	2593	600	200	1200 x 800	1269 x 809 x 270	33



MultiVario-Transporter Modular system

The MultiVario-Transporter can be altered, interchanged and supplemented in many ways. The system components are simply inserted into the basic element 2590-2593 and bolted tight.

Tubular steel and profile steel welded, powder coated, surface durably protected, resistant to impact and scratches. Platform made of derived timber material boards, surface beech design.

2 swivel and 2 fixed-wheel castors, TPE tyres, 160 x 40 or 200 x 40 mm, hubs with groove ball bearing.

Swivel castors with wheel locks.

Height of loading platform:

TPE 160 Ø = 228 mm

TPE 200 Ø = 270 mm

Pneumatic tyres 220 Ø = 285 mm

Panelled end platform carts Double open side platform carts

2510 - 2513 | 2520 - 2523

Panelled end made of derived timber material boards, surface beech grain.

End panel height: 500 mm

Open sided platform carts Closed platform carts

2530 - 2533 | 2550 - 2553

Panelled ends and panelled sides made of derived timber material boards, surface beech grain.

End panel height: 500 mm

Side panel height: 500 mm

Closed platform cart with one detachable side panel.



2510 | 2511 | 2512 | 2513



2520 | 2521 | 2522 | 2523



2530 | 2531 | 2532 | 2533



2550 | 2551 | 2552 | 2553



	Order no.	Capacity kg	Wheel-Ø mm	Platform size L x W mm	Outside dimensions L x W x H mm	Net weight kg	
Panelled end platform carts	2510	500	160	850 x 500	970 x 509 x 948	27	
	2511	600	200	1000 x 600	1120 x 609 x 990	31	
	2512	600	200	1000 x 700	1120 x 709 x 990	36	
	2513	600	200	1200 x 800	1320 x 809 x 990	42	
Double open-side platform carts	2520	500	160	850 x 500	1030 x 509 x 948	31	
	2521	600	200	1000 x 600	1180 x 609 x 990	37	
	2522	600	200	1000 x 700	1180 x 709 x 990	43	
	2523	600	200	1200 x 800	1380 x 809 x 990	49	
Open sided platform carts	2530	500	160	850 x 480	1030 x 509 x 948	36	
	2531	600	200	1000 x 580	1180 x 609 x 990	42	
	2532	600	200	1000 x 680	1180 x 709 x 990	49	
	2533	600	200	1200 x 780	1380 x 809 x 990	56	
Closed platform carts	2550	500	160	850 x 450	1030 x 509 x 948	41	
	2551	600	200	1000 x 550	1180 x 609 x 990	48	
	2552	600	200	1000 x 650	1180 x 709 x 990	54	
	2553	600	200	1200 x 750	1380 x 809 x 990	63	

Accessories
on pages 183-185



1510 | 1511 | 1512 | 1513



1520 | 1521 | 1522 | 1523



1530 | 1531 | 1532 | 1533



1550 | 1551 | 1552 | 1553



MultiVario-Transporter Modular system

The MultiVario-Transporter can be altered, interchanged and supplemented in many ways. The system components are simply inserted into the basic element 2590-2593 and bolted tight.

Tubular steel and profile steel welded, powder coated, surface durably protected, resistant to impact and scratches. Platform made of derived timber material boards, surface beech design.

2 swivel and 2 fixed-wheel castors, TPE tyres, 160 x 40 or 200 x 40 mm, hubs with groove ball bearing.

Swivel castors with wheel locks.

Height of loading platform:

TPE 160 Ø = 228 mm

TPE 200 Ø = 270 mm

Pneumatic tyres 220 Ø = 285 mm

Panelled end platform carts Double open side platform carts

1510 - 1513 | 1520 - 1523

Ends made of wire lattice 50 x 50 x 4 mm.

End panel height: 500 mm

Open sided platform carts Wire cage carts

1530 - 1533 | 1550 - 1553

Ends and sides made of wire lattice 50 x 50 x 4 mm.

Height of ends: 500 mm

Height of sides: 500 mm

Wire cage cart with one detachable side.

	Order no.	Capacity kg	Wheel-Ø mm	Platform size L x W mm	Outside dimensions L x W x H mm	Net weight kg
Panelled end platform carts	1510	500	160	850 x 500	970 x 509 x 948	26
	1511	600	200	1000 x 600	1120 x 609 x 990	29
	1512	600	200	1000 x 700	1120 x 709 x 990	34
	1513	600	200	1200 x 800	1320 x 809 x 990	40
Double open-side platform carts	1520	500	160	850 x 500	1030 x 509 x 948	29
	1521	600	200	1000 x 600	1180 x 609 x 990	33
	1522	600	200	1000 x 700	1180 x 709 x 990	39
	1523	600	200	1200 x 800	1380 x 809 x 990	45
Open sided platform carts	1530	500	160	850 x 480	1030 x 509 x 948	32
	1531	600	200	1000 x 580	1180 x 609 x 990	36
	1532	600	200	1000 x 680	1180 x 709 x 990	42
	1533	600	200	1200 x 780	1380 x 809 x 990	48
Wire cage carts	1550	500	160	850 x 450	1030 x 509 x 948	35
	1551	600	200	1000 x 550	1180 x 609 x 990	40
	1552	600	200	1000 x 650	1180 x 709 x 990	45
	1553	600	200	1200 x 750	1380 x 809 x 990	53

Accessories
on pages 183-185

**Box carts**

2560 | 2561 | 2562 | 2563

Ends and sides made of derived timber material boards, Height of sides 250 mm. All sides singly detachable.



2560 | 2561 | 2562 | 2563



1580 | 1581 | 1582 | 1583

Side frame carts

1580 | 1581 | 1582 | 1583

Height of side frames 720 mm

Bale trolleys

2541 | 2542 | 2543

Sides made of derived timber material boards, surface beech grain.

Height of sides 620/750 mm



2541 | 2542 | 2543



2571 | 2572 | 2573

Bale trolleys

2571 | 2572 | 2573

2 tubular steel side frames with intermediate uprights at intervals of approx. 130 mm.

Height of sides 750 mm



	Order no.	Capacity kg	Wheel-Ø mm	Platform size L x B mm	Outside dimensions L x W x H mm	Net weight kg	
Box carts	2560	500	160	850 x 440	970 x 509 x 948	30	
	2561	600	200	1000 x 540	1120 x 609 x 990	36	
	2562	600	200	1000 x 640	1120 x 709 x 990	40	
	2563	600	200	1200 x 740	1320 x 809 x 990	46	
Side frame carts	1580	500	160	850 x 440	910 x 509 x 948	29	
	1581	600	200	1000 x 540	1060 x 609 x 990	35	
	1582	600	200	1000 x 640	1060 x 709 x 990	40	
	1583	600	200	1200 x 740	1260 x 809 x 990	44	
Bale trolleys	2541	600	200	1000 x 540	1060 x 609 x 1025	42	
	2542	600	200	1000 x 640	1060 x 709 x 1025	45	
	2543	600	200	1200 x 740	1260 x 809 x 1025	54	
	2571	600	200	1000 x 540	1060 x 609 x 1025	39	
	2572	600	200	1000 x 640	1060 x 709 x 1025	42	
	2573	600	200	1200 x 740	1260 x 809 x 1025	48	

Accessories
on pages 183-185

TABLE TOP CARTS



Ergonomics:

Push handle can be retrofitted. For the optimal grip position the height can be adjusted by means of plastic clamps.



Platforms:

Table top carts with flush platform or with rim. Various surface materials available.



TPE castor:

The innovative easy-running TPE-castor in the attractive fetra design is non-marking and odourless. Particularly smooth-running groove ball bearing.



Modular system:

Multi-functional modular system with the proven fetra „Insert & Bolt Principle“. MultiVario transport carts can be changed, swapped and added-on in many ways.





Heavy table top carts Modular system

Tubular steel and sectional steel, welded and powder-coated, surface durably protected, resistant to impact and scratches, shelves made of derived timber material boards, surface beech grain.

2 swivel and 2 fixed-wheel castors with TPE tyres 160 x 40 mm resp. 200 x 40 mm.

Swivel castors with wheel locks.

Capacity upper and middle shelf 200 kg.

2496

Square platforms 600 x 600 mm.
2 shelves.

2400 | 2401 | 2402 | 2403

Rectangular platforms in 4 sizes.
2 shelves.

2416

as 2496, but with 3 shelves.

2420 | 2421 | 2422 | 2423

as 2400-2403, but with 3 shelves.

2440 | 2441 | 2442 | 2443

as 2400-2403, but with 4 shelves.

Accessories

Steel plate drawer 2149

Add-on kit for table top carts, with ball pull-out and cylinder lock. H x W x D inside
105 x 410 x 475 mm.

Can not be retrofitted.



2496



2400 | 2401 | 2402 | 2403



2416



2420 | 2421 | 2422 | 2423



2440 | 2441 | 2442 | 2443

	Order no.	Capacity kg	Wheel-Ø mm	Platform size L x W mm	Outside dimensions L x W x H mm	No. of shelves	Shelf heights mm	Net weight kg
Table top carts	2496	500	160	600 x 600	737 x 609 x 860	2	228, 860	32
	2400	500	160	850 x 500	1047 x 509 x 860	2	228, 860	36
	2401	600	200	1000 x 600	1197 x 609 x 900	2	270, 900	44
	2402	600	200	1000 x 700	1197 x 709 x 900	2	270, 900	49
	2403	600	200	1200 x 800	1397 x 809 x 900	2	270, 900	58
	2416	500	160	600 x 600	737 x 609 x 860	3	228, 544, 860	44
	2420	500	160	850 x 500	1047 x 509 x 860	3	228, 544, 860	50
	2421	600	200	1000 x 600	1197 x 609 x 900	3	270, 585, 900	61
	2422	600	200	1000 x 700	1197 x 709 x 900	3	270, 585, 900	67
	2423	600	200	1200 x 800	1397 x 809 x 900	3	270, 585, 900	79
	2440	500	160	850 x 500	1047 x 509 x 1179	4	228, 544, 860, 1179	64
	2441	600	200	1000 x 600	1197 x 609 x 1218	4	270, 585, 900, 1218	78
	2442	600	200	1000 x 700	1197 x 709 x 1218	4	270, 585, 900, 1218	88
	2443	600	200	1200 x 800	1397 x 809 x 1218	4	270, 585, 900, 1218	107



2496B



2400B | 2401B | 2402B | 2403B



2416B



2420B | 2421B | 2422B | 2423B



Paper roll holder

mounting kit for trolleys. Suitable for paper rolls up to 210 mm in diameter and 210 mm in width.

For details see page 185.



Bottle holder

Tubular strut with multiple holes, with clamping bracket for attaching in almost any position.

For details see page 185.



Waste collector

with clamp for tube-Ø 27 mm. Suitable for 120 litre rubbish bags.

For details see page 185.



Tablet holder

For details see page 185.

Heavy table top carts Modular system

Tubular steel and sectional steel, welded and powder-coated, surface durably protected, resistant to impact and scratches.

Platforms made of steel sheet, flush with frame, neatly welded, powder coated blue RAL 5007.

2 swivel and 2 fixed-wheel castors with TPE tyres 160 x 40 mm resp. 200 x 40 mm.

Swivel castors with wheel locks.

Capacity upper and middle shelf 200 kg.

2496B

Square platforms 600 x 600 mm, platforms made of steel sheet, flush with frame, powder coated.

2400B | 2401B | 2402B | 2403B

Rectangular platforms in 4 sizes, made of steel sheet, flush with frame, powder coated.

2416B

as 2496B, but with 3 shelves.

2420B | 2421B | 2422B | 2423B

as 2400B-2403B, but with 3 shelves.

	Order no.	Capacity kg	Wheel-Ø mm	Platform size L x W mm	Outside dimensions L x W x H mm	No. of shelves	Shelf heights mm	Net weight kg
Table top carts with platforms made of sheet steel	2496B	500	160	600 x 600	737 x 609 x 860	2	228, 860	42
	2400B	500	160	850 x 500	1047 x 509 x 860	2	228, 860	45
	2401B	600	200	1000 x 600	1197 x 609 x 900	2	270, 900	56
	2402B	600	200	1000 x 700	1197 x 709 x 900	2	270, 900	61
	2403B	600	200	1200 x 800	1397 x 809 x 900	2	270, 900	78
Table top carts with platforms made of sheet steel	2416B	500	160	600 x 600	737 x 609 x 860	3	228, 544, 860	50
	2420B	500	160	850 x 500	1047 x 509 x 860	3	228, 544, 860	59
	2421B	600	200	1000 x 600	1197 x 609 x 900	3	270, 585, 900	71
	2422B	600	200	1000 x 700	1197 x 709 x 900	3	270, 585, 900	77
	2423B	600	200	1200 x 800	1397 x 809 x 900	3	270, 585, 900	99
Paper roll holder	1396	-	-	-	-	-	-	4
Bottle holder	1391	-	-	-	-	-	-	1
Waste collector	1397	-	-	-	-	-	-	4
Tablet holder	28TH	-	-	-	-	-	-	2

Accessories
on pages 183-185



Heavy table top carts Modular system

Tubular steel and sectional steel, welded and powder-coated, surface durably protected, resistant to impact and scratches.

Steel sheet trays with 10 mm high rim, welded oil-tight

2 swivel and 2 fixed-wheel castors with TPE tyres 160 x 40 mm resp. 200 x 40 mm.

Swivel castors with wheel locks.

Capacity upper shelf 200 kg.

2496W

Square platforms 600 x 600 mm, trays made of steel sheet, with rim 10 mm high, welded oil-tight, powder coated.

2400W | 2401W | 2402W | 2403W

Rectangular platforms in 4 sizes, trays made of steel sheet, with rim 10 mm high, welded oil-tight, powder coated.

2416W

as 2496W, but with 3 shelves.

Capacity upper and middle shelf 200 kg.

2420W | 2421W | 2422W | 2423W

as 2400W-2403W, but with 3 shelves.

Capacity upper and middle shelf 200 kg.



2496W



2400W | 2401W | 2402W | 2403W



2416W



2420W | 2421W | 2422W | 2423W



Paper roll holder

mounting kit for trolleys. Suitable for paper rolls up to 210 mm in diameter and 210 mm in width.

For details see page 185.



Bottle holder

Tubular strut with multiple holes, with clamping bracket for attaching in almost any position.

For details see page 185.



Waste collector

with clamp for tube-Ø 27 mm. Suitable for 120 litre rubbish bags.

For details see page 185.



Tablet holder

For details see page 185.

	Order no.	Capacity kg	Wheel-Ø mm	Platform size L x W mm	Outside dimensions L x W x H mm	No. of shelves	Shelf heights mm	Net weight kg
Table top carts with steel plate trays	2496W	500	160	600 x 600	737 x 609 x 860	2	228, 860	38
	2400W	500	160	850 x 500	1047 x 509 x 860	2	228, 860	40
	2401W	600	200	1000 x 600	1197 x 609 x 900	2	270, 900	50
	2402W	600	200	1000 x 700	1197 x 709 x 900	2	270, 900	54
	2403W	600	200	1200 x 800	1397 x 809 x 900	2	270, 900	66
Table top carts with steel plate trays	2416W	500	160	600 x 600	737 x 609 x 860	3	228, 544, 860	47
	2420W	500	160	850 x 500	1047 x 509 x 860	3	228, 544, 860	54
	2421W	600	200	1000 x 600	1197 x 609 x 900	3	270, 585, 900	64
	2422W	600	200	1000 x 700	1197 x 709 x 900	3	270, 585, 900	70
	2423W	600	200	1200 x 800	1397 x 809 x 900	3	270, 585, 900	88
Paper roll holder	1396	-	-	-	-	-	-	4
Bottle holder	1391	-	-	-	-	-	-	1
Waste collector	1397	-	-	-	-	-	-	4
Tablet holder	28TH	-	-	-	-	-	-	2

Table top carts with trays
Modular system

Steel construction, welded. Tubular steel hoop and steel plate trays screwed. Trays oil-tight, rim 40 mm high, powder coated blue RAL 5007. 2 swivel and 2 fixed-wheel castors with TPE tyres, hubs with groove ball bearing. Swivel castors with wheel locks. Capacity per upper and middle shelf 200 kg.

4840 | 4842

Construction and dimensions as 4820 | 4822, but upper shelf with rim 150 mm.

2722

Top steel tray 100 mm high, oil-tight. Base with conical drain and drain tap 1/2".

Grid with mesh width of 31 x 31 mm, loosely inserted, flush at the top, hot-dip galvanized.

Lower steel plate tray 25 mm high, oil-tight.

2 swivel and 2 fixed-wheel castors, solid rubber tyres, hubs with groove ball bearing. Swivel castors with wheel locks.

Capacity per upper shelf 100 kg.



2722 Example of use

Accessories
 on pages 183-185



4820 | 4822



4830 | 4832



4920 | 4922



4930 | 4932



4840 | 4842



2722

	Order no.	Capacity kg	Wheel-Ø mm	Platform size L x W mm	Outside dimensions L x W x H mm	No. of shelves	Shelf heights mm	Net weight kg
Table top carts	4820	400	160	850 x 500	1021 x 500 x 870	2	207, 829	36
	4822	400	200	1000 x 700	1171 x 700 x 910	2	248, 870	47
	4830	400	160	850 x 500	1021 x 500 x 870	3	207, 519, 829	46
	4832	400	200	1000 x 700	1171 x 700 x 910	3	248, 560, 870	61
	4920	400	160	850 x 500	986 x 500 x 1065	2	207, 829	37
	4922	400	200	1000 x 700	1136 x 700 x 1105	2	248, 870	50
	4930	400	160	850 x 500	986 x 500 x 1065	3	207, 519, 829	47
	4932	400	200	1000 x 700	1136 x 700 x 1105	3	248, 560, 870	64
	4840	400	160	850 x 500	1021 x 500 x 880	2	207, 829	43
	4842	400	200	1000 x 700	1171 x 700 x 1020	2	248, 870	55
2722	300	125	1000 x 600	1136 x 611 x 1030	2	181, 901	52	



Light table top carts Modular system

Table top carts, tubular steel welded and powder coated, surface durably protected, resistant to impact and scratches, shelves made of derived timber material boards, in a frame of angle steel, height of rim 12 mm.

2 swivel and 2 fixed-wheel castors with TPE tyres, hubs with groove ball bearing.

Swivel castors with wheel locks.

Capacity upper and middle shelf 80 kg.



2740 | 2742 | 2744 | 2746



2750 | 2752 | 2754 | 2756

2740 | 2742 | 2744 | 2746

2750 | 2752 | 2754 | 2756

with a high push bar.



2940 | 2942 | 2944 | 2946



2950 | 2952 | 2954 | 2956

2940 | 2942 | 2944 | 2946

2950 | 2952 | 2954 | 2956

Constructed as above, but with a horizontal push bar.



Paper roll holder

For details see page 185.



Bottle holder

For details see page 185.



Scanner holder

For details see page 185.



Tablet holder

For details see page 185.

	Order no.	Capacity kg	Wheel-Ø mm	Platform size L x B mm	Outside dimensions L x W x H mm	No. of shelves	Shelf heights mm	Net weight kg
Table top carts	2740	300	125	850 x 500	986 x 511 x 1039	2	200, 820	28
	2742	300	125	1000 x 600	1136 x 611 x 1039	2	200, 820	36
	2744	300	125	1000 x 700	1136 x 711 x 1039	2	200, 820	37
	2746	300	125	1200 x 800	1336 x 811 x 1039	2	200, 820	48
	2750	300	125	850 x 500	986 x 511 x 1039	3	200, 510, 820	35
	2752	300	125	1000 x 600	1136 x 611 x 1039	3	200, 510, 820	49
	2754	300	125	1000 x 700	1136 x 711 x 1039	3	200, 510, 820	51
	2756	300	125	1200 x 800	1336 x 811 x 1039	3	200, 510, 820	66
	2940	300	125	850 x 500	1021 x 511 x 830	2	200, 820	29
	2942	300	125	1000 x 600	1171 x 611 x 830	2	200, 820	36
	2944	300	125	1000 x 700	1171 x 711 x 830	2	200, 820	37
	2946	300	125	1200 x 800	1371 x 811 x 830	2	200, 820	48
2950	300	125	850 x 500	1021 x 511 x 830	3	200, 510, 820	36	
2952	300	125	1000 x 600	1171 x 611 x 830	3	200, 510, 820	49	
2954	300	125	1000 x 700	1171 x 711 x 830	3	200, 510, 820	51	
2956	300	125	1200 x 800	1371 x 811 x 830	3	200, 510, 820	66	



3740 | 3742



3760 | 3762



2622

Light table top carts

Modular system

3740 | 3742 | 3760 | 3762

Tubular steel welded and powder coated, surface durably protected, resistant to impact and scratches, shelves made of derived timber material boards resp. boxes, in a frame of angle steel. Boards with 12 mm rim. Boxes with 45 mm rim.

With a high push bar.

2 swivel and 2 fixed-wheel castors with TPE tyres, hubs with groove ball bearing.

Swivel castors with wheel locks.

Capacity upper shelf 80 kg.

Inside dimension of boxes

L x W x H mm:

810 x 450 x 45 mm when platform size 850 x 500 mm

960 x 550 x 45 mm when platform size 1000 x 600 mm

2622

Construction and dimensions as 2742, 2 sheet steel drawers with ball pull-out and cylinder lock.

Inside dimension of drawer

H x W x D

105 x 415 x 490 mm.

Capacity upper shelf 80 kg.

Capacity per drawer 25 kg.



Drawer subdivision-set

made of galvanized steel sheet, insertable. 2 longitudinal partitions and 6 dividing sheets.



Waste collector

with clamp for tube-Ø 27 mm. Suitable for 120 litre rubbish bags. .

For details see page 185.



Clip board upright DIN A4

See also page 185.



Storage tray

See also page 185.

	Order no.	Capacity kg	Wheel-Ø mm	Platform size L x W mm	Outside dimensions L x W x H mm	No. of shelves	Shelf heights mm	Net weight kg
Table top carts	3740	300	125	850 x 500	986 x 511 x 1039	2	200, 820	28
	3742	300	125	1000 x 600	1136 x 611 x 1039	2	200, 820	34
	3760	300	125	850 x 500	986 x 511 x 1039	2	200, 820	29
	3762	300	125	1000 x 600	1136 x 611 x 1039	2	200, 820	35
Table top carts	2622	300	125	1000 x 600	1136 x 611 x 1039	2	200, 820	49
Subdivision-set	2148/ES	-	-	-	-	-	-	3
Waste collector	1397	-	-	-	-	-	-	4
Clip board	1290	-	-	-	-	-	-	1
Storage tray	1381	25	-	-	-	-	-	4

WORKSHOP CARTS

Skirting:

Worktop with 80 mm high sheet steel skirting on 3 sides to prevent objects from dropping.



Central lock:

Cart is completely lockable by means of cylinder lock.



TPE castor:

The innovative easy-running TPE-castor in the attractive fetra design is non-marking and odourless. Particularly smooth-running groove ball bearing.



Safety:

Handle rails integrated for flush design, no risk of injury.





2450/7016



12450/7016



2452/7016



12452/7016



2456/7016



12456/7016



Drawer subdivision-set

made of galvanized steel sheet, insertable. 1 longitudinal partition and 4 dividing sheets.

Workshop carts

Steel construction.
 Worktop composite panel 20 mm.
 2 swivel and 2 fixed-wheel castors, TPE tyres 160 x 40 mm, swivel castors wheels with lock.
 Powder coated, carcass grey RAL 7035, front anthracite grey RAL 7016.
 For technical reasons relating to transport the working platform the worktop and the wheels are not mounted. Easy self assembly.
 Capacity per shelves 80 kg.

2450/7016

With 1 cupboard, 1 fixed and 2 adjustable shelves, and drawers with ball bearing slide. Centrally lockable by cylinder lock.
 6 drawers
 H x W x D : 95 x 280 x 470 mm
 Capacity per drawer 35 kg.

2452/7016

With 1 cupboard, 1 fixed and 2 adjustable shelves, and drawers with ball bearing slide. Centrally lockable by cylinder lock.
 4 drawers
 H x W x D
 1 pc. 105 x 280 x 470 mm
 2 pcs. 160 x 280 x 470 mm
 1 pc. 210 x 280 x 470 mm
 Capacity per drawer 35 kg.

2456/7016

With 1 cupboard with double door without separation wall. 2 adjustable shelves. Doors centrally lockable by cylinder lock. Maximum opening angle 120°.
 Useful depth: 873 mm
 Useful width: 465 mm
 Opening width: 784 mm

12450/7016 |

12452/7016 |

12456/7016

Workshop carts with skirting on three sides 80 mm high, made of powder coated steel sheet.

Accessories

on pages 183-185

	Order no.	Capacity kg	Wheel-Ø mm	Platform size L x W mm	Outside dimensions L x W x H mm	Net weight kg
Workshop carts	2450/7016	400	160	985 x 590	1080 x 590 x 915	66
	2452/7016	400	160	985 x 590	1080 x 590 x 915	62
	2456/7016	400	160	985 x 590	1080 x 590 x 915	48
Workshop carts with skirting	12450/7016	400	160	985 x 590	1080 x 590 x 995	71
	12452/7016	400	160	985 x 590	1080 x 590 x 995	67
	12456/7016	400	160	985 x 590	1080 x 590 x 995	53
Drawer subdivison set	2146			1 longitudinal partition and 4 dividing sheets		



Light workshop carts Modular system

Light workshop carts

Tubular steel welded and powder coated, surface durably protected, resistant to impact and scratches, shelves made of derived timber material boards, in a frame of angle steel, height of rim 12 mm.

2 swivel and 2 fixed-wheel castors with TPE tyres, hubs with groove ball bearing.

Swivel castors with wheel locks.

Working height: 820 mm

Total height: 1040 mm

Total length: 1130 mm

Capacity per shelf in cupboards
30 kg, per drawer 25 kg.

2632

3 platforms with all-round skirting, 12 mm high. 1 lockable steel cupboard with 1 fixed and 2 adjustable shelves, 500 mm wide 600 mm deep and 600 mm high. Powder coated, grey carcass RAL 7035, front blue RAL 5007.

Shelf heights: 200, 510, 820 mm

2633

1 platform with all-round skirting, 12 mm high. 2 lockable steel cupboards with 1 fixed and 2 adjustable shelves, 500 mm wide 600 mm deep and 600 mm high.

2634

3 platforms with all-round skirting, 12 mm high. Centrally lockable cupboard with 4 drawers (3 x 120 mm high and 1 x 180 mm high) with ball pull-out and pull-out stop. 4/5-pull-out. 500 mm wide, 600 mm deep and 600 mm high.

Shelf heights: 200, 510, 820 mm

2635

1 platform with skirting, 12 mm high. 1 steel cupboard as 2632 and 1 cupboard with drawers as 2634.



2632



2633



2634



2635



Steel plate drawer

Add-on kit for table top carts, with ball pull-out and cylinder lock.

Height x Width x Depth inside
105 x 410 x 475 mm.

Can not be retrofitted.



Drawer subdivision-set

made of galvanized steel sheet, insertable. 2 longitudinal partitions and 6 dividing sheets. For drawers in cupboards order no. 2148*. For single drawers order no. 2148/ES.



Paper roll holder

For details see page 185.



Tablet holder

For details see page 185.

* Please add order no. of the respective cart to this order no. (e.g.: 2148-2634)

	Order no.	Capacity kg	Wheel-Ø mm	Platform size LxW mm	Outside dimensions LxW x H mm	No. of shelves	Net weight kg
Workshop carts	2632	300	125	1000 x 600	1130 x 600 x 1040	3	61
	2633	300	125	1000 x 600	1130 x 600 x 1040	1	69
	2634	300	125	1000 x 600	1130 x 600 x 1040	3	78
	2635	300	125	1000 x 600	1130 x 600 x 1040	1	87
Steel plate drawer	2149	-	-	-	-	-	6
Drawer subdivision-set*	2148	-	-	-	-	-	3
Drawer subdivision-set	2148/ES	-	-	-	-	-	3
Paper roll holder	1396	-	-	-	-	-	4

Accessories
on pages 183-185

Workshop carts
Modular system

Sectional/tubular steel construction, powder coated, blue RAL 5007, grey carcass RAL 7035.
Surface out of beech plywood, 22 mm thick with skirting on 3 sides, 80 mm high.
2 swivel and 2 fixed-wheel castors with TPE tyres, hubs with groove ball bearing.
Swivel castors with wheel locks.
Height of surface: 850 mm



2435



2436



2437



2438

2435

1 additional shelf and 1 lockable steel cupboard with leaf-door, 1 fixed and 2 adjustable shelves. 500 mm wide, 600 mm deep and 600 mm high.
Shelf heights: 226, 537, 850 mm

2436

As 2435 but with 1 additional drawer with ball pull-out and cylinder lock.
H x W x D =
105 x 415 x 490 mm
Without additional shelf.
Shelf heights: 226, 850 mm

2437

1 additional shelf and 1 centrally lockable cupboard of drawers, 3 drawers 120 mm high and 1 drawer 180 mm high. Ball pull-out and pull-out lock. 4/5-pull-out.
500 mm wide, 600 mm deep and 600 mm high.
Shelf heights: 226, 537, 850 mm

2438

1 steel cupboard and 1 cupboard of drawers as 2435 and 2437.
Capacity per shelf in cupboards 30 kg, 25 kg per drawer.



Vice
Forged.



Drawer subdivision-set*
Made of galvanized steel sheet, insertable. 2 longitudinal partitions and 6 dividing sheets



Cable drum
Thermo protected (acc. to VDE) coated cable 3 x 1.5.
Add-on kit. Lockable with padlock (not included in delivery).



Drum for compressed air hose
20 m hose, type NW 9
Add-on kit.
Lockable with padlock (not included in delivery).



	Order no.	Capacity kg	Wheel-Ø mm	Platform size L x W mm	Outside dimensions L x W x H mm	Net weight kg
Workshop carts	2435	400	160	1120 x 650	1220 x 650 x 930	68
	2436	400	160	1120 x 650	1220 x 650 x 930	66
	2437	400	160	1120 x 650	1220 x 650 x 930	86
	2438	400	160	1120 x 650	1220 x 650 x 930	94
Vice, jaw width 100 mm	2144	-	-	-	-	5
Vice, jaw width 125 mm	2145	-	-	-	-	11
Drawer subdivision-set*	2148	-	-	-	-	3
Cable drum	2151	-	-	-	-	5
Drum for compressed air hose	2153	-	-	-	-	4

* Please add order no. of the respective cart to this order no. (e.g.: 2148-2437)

Add-on kits

Cable drum and compressed air hose drum also suitable for all table top and workshop carts (pages 42-44).

Accessories
on pages 183-185



Heavy workshop carts Modular system

Steel tube and sectional steel welded, powder coated.

Carcass grey RAL 7035, front blue RAL 5007. Surface durably protected, resistant to impact and scratches, platform made of derived timber material boards, surface beech grain.

2 swivel and 2 fixed-wheel castors with TPE tyres, hubs with groove ball bearing or pneumatic tyres, additional charge.

Swivel castors with wheel locks.

Shelf heights:

TPE tyres: 270/900 mm

Pneumatic tyres: 285/915 mm

Capacity upper shelf 200 kg.

2432 | 2433

1 lockable steel cupboard with leaf door, 1 fixed and 2 adjustable shelves:

2432: 500 mm wide, 700 mm deep, 600 mm high

2433: 600 mm wide, 800 mm deep, 600 mm high

Powder coated, grey carcass RAL 7035, front blue RAL 5007.

2474

1 centrally lockable drawer cupboard with 3 drawers 120 mm high and 1 drawer 180 mm high. Ball bearing slide. 4/5-pull-out. 500 mm wide, 700 mm deep and 600 mm high.

2475

2 lockable steel cupboards with 1 fixed and 2 adjustable shelves, 500 mm wide, 700 mm deep and 600 mm high.

2476

1 steel cupboard and 1 drawer cupboard as 2432/2474.

Capacity per shelf in cupboards 30 kg, per shelf 25 kg.

* Please add order no. of the respective cart to this order no. (e.g.: 2148-2474)



2432 | 2433



2474



2475



2476



Steel plate drawer

Add-on kit for table top carts, with ball pull-out and cylinder lock.

Height x Width x Depth inside: 105 x 410 x 475 mm.

Can not be retrofitted.



Drawer subdivision-set

Made of galvanized steel sheet, insertable. 2 longitudinal partitions and 6 dividing sheets. For drawers in cupboards order no. 2148*. For single drawers order no. 2148/ES.



Table tops

For all types (not suitable for 2433) on this page beech plywood 22 mm, size 1150 x 750 mm, to be bolted onto existing platform.

	Order no.	Capacity kg	Wheel-Ø mm	Platform size L x W mm	Outside dimensions L x W x H mm	Net weight kg
Workshop carts	2432	600	200	1050 x 700	1197 x 709 x 900	79
	2433	600	200	1250 x 800	1397 x 809 x 900	86
	2474	600	200	1050 x 700	1197 x 709 x 900	89
	2475	600	200	1050 x 700	1197 x 709 x 900	102
	2476	600	200	1050 x 700	1197 x 709 x 900	114
Steel plate drawer	2149	–	–	–	–	6
Drawer subdivision-set*	2148	–	–	–	–	3
Drawer subdivision-set	2148/ES	–	–	–	–	3
Table tops	2140	–	–	1150 x 750	–	14

ROLLING DESKS

Field of application:

Mobile workstations for operations, warehouse and dispatch. Extremely handy and manoeuvrable.

Writing surface:

Horizontal or inclined. Inclined version with stop bar.



Large wheel diameter:

Easy crossing of edges and sills.



Many versions:

With shelves, lockable cupboards or drawers for computer accessories.



Rolling desks

Steel tube and sectional steel welded, bolted construction, powder coated blue RAL 5007. 4 swivel castors with TPE tyres 125 x 32 mm, 2 wheel locks, hubs with plain bearings.

Easy movement across angles and barriers because of the big wheels.

5833

Surface made of derived timber material, 605 mm wide und 589 mm deep.

2 screw-down shelves, upper shelf centred shrewable for the possibility of 2 folders on top of each other.

Capacity per shelf 50 kg.

Horizontal writing surface with cut-out as a pen tray.

5834

Surface made of derived timber material, 605 mm wide und 589 mm deep.

2 screw-down shelves, upper shelf centred shrewable for the possibility of 2 folders on top of each other.

Capacity per shelf 50 kg.

Writing surface inclined approx. 10°, with stop bar.

5835

As 5833, but with 1 lockable steel cupboard (W x D x H: 500 x 600 x 600 mm) with leaf-door. 1 fixed and 2 adjustable shelves. Powder coated carcass RAL 7035, blue front RAL 5007. Capacity per shelf in cupboard 30 kg.

5836

As 5834, but with 1 lockable steel cupboard (W x D x H: 500 x 600 x 600 mm) with leaf-door. 1 fixed and 2 adjustable shelves. Powder coated carcass RAL 7035, blue front RAL 5007. Capacity per shelf in cupboard 30 kg.



5833



5834



5835



5836



Example of use

	Order no.	Capacity kg	Wheel-Ø mm	Platform size W x D mm	Outside dimensions W x D x H mm	Surface height mm	Net weight kg
Rolling desks	5833	100	125	500 x 600	605 x 610 x 1195	1195	25
	5834	100	125	500 x 600	605 x 610 x 1195	1100, 1195	25
	5835	100	125	500 x 600	605 x 610 x 1195	1195	46
	5836	100	125	500 x 600	605 x 610 x 1195	1100, 1195	46



5839



5844



5837



5838



Example of use

Rolling desks

Steel tube and sectional steel welded, bolted construction, powder coated blue RAL 5007. 4 swivel castors with TPE tyres 125 x 32 mm, 2 wheel locks, hubs with plain bearings.

Easy movement across angles and barriers because of the big wheels.

5839

As 5835, but additionally with 1 lockable keyboard drawer with full extension and pull-out mouse pad. Horizontal writing desk, with cable slots in desk-top and cupboard. Delivery without decoration.

5844

1 writing desk made of sheet steel, powder coated carcass RAL 7035. Desktop foldable, with stick-on writing pad, lockable. 2 screw-down shelves, upper shelf centred shrewable for the possibility of 2 folders on top of each other. Capacity per shelf 50 kg. Writing surface inclined approx. 18°, with stop bar.

5837

surface 1100 mm wide und 589 mm deep, with stop bar. 2 screw-down shelves, upper shelf centred shrewable for the possibility of 2 folders on above each other. Capacity per shelf 50 kg.

5838

As 5837, but with 1 lockable steel cupboard (W x D x H: 500 x 600 x 600 mm) with leafdoor. 1 fixed and 2 adjustable shelves. Powder coated carcass RAL 7035, blue front RAL 5007. Capacity per shelf in cupboard 30 kg.

	Order no.	Capacity kg	Wheel-Ø mm	Platform size W x D mm	Outside dimensions W x D x H mm	Surface height mm	Net weight kg
Rolling desks	5839	150	125	650 x 650	650 x 650 x 1110	1110	53
	5844	150	125	500 x 600	600 x 615 x 1320	1150, 1320	42
	5837	100	125	1000 x 600	1105 x 610 x 1195	1100, 1195	39
	5838	100	125	1000 x 600	1105 x 610 x 1195	1100, 1195	60



Roller cupboards 2445

Leaf-door cupboard, lockable, 1 fixed and 2 adjustable shelves, 500 mm wide, 600 mm deep and 600 mm high. Surface composite panel, 19 mm thick with skirting on 3 sides, 80 mm high. 2 swivel and 2 fixed-wheel castors, TPE tyres. Swivel castors with wheel locks. Powder coated, grey carcass RAL 7035, blue front RAL 5007. Surface height 800 mm.



2445



2446

2446

Cupboard of drawers, centrally lockable, 3 drawers 120 mm high and 1 drawer 180 mm high. Ball pull-out and pull-out lock otherwise as 2445.

Rolling desks 2448

As 2445 but instead of a work surface it has a fit-on desk-top made of powder coated steel plate. Desktop foldable. Surface height 1034/1197 mm. Writing surface inclined approx. 18°, with stop bar.



2448



2449

2449

As 2446 but instead of a work surface it has a fit-on desk-top made of powder coated steel plate. Desktop foldable. Surface height 1034/1197 mm. Capacity per shelf in cupboards 30 kg, 25 kg per drawer. Writing surface inclined approx. 18°, with stop bar.



Drawer subdivision-set*

Made of galvanized steel sheet, insertable. 2 longitudinal partitions and 6 dividing sheets.

* Please add order no. of the respective cart to this order no. (e.g.: 2148-2446)

	Order no.	Capacity kg	Wheel-Ø mm	Platform size W x D mm	Outside dimensions W x D x H mm	Net weight kg
Roller cupboards	2445	150	125	650 x 550	650 x 550 x 875	35
	2446	150	125	650 x 550	650 x 550 x 875	54
Rolling desks	2448	150	125	-	650 x 550 x 1200	41
	2449	150	125	-	650 x 550 x 1200	60
Accessorie	2148*			Drawer subdivison-set		

Rolling tables

5862

Steel tube and sectional steel welded, bolted construction, powder coated blue RAL 5007. Table board composite panel, 20 mm thick, surface out of beech decoration.

2 screw-down shelves, variable distance of 50 mm, 1 x folder height possible.

4 swivel castors with TPE tyres 125 x 32 mm, 2 wheel locks, hubs with plain bearings.

Capacity per shelf 50 kg.

Table height 910 mm.

Screw-down shelves 300 und 670 mm high, variable distance of 50 mm.

5864

As 5862, but with 1 lockable steel cupboard with leaf-door, 1 fixed and 2 adjustable shelves.

Width 500 mm

Depth 600 mm

Height 600 mm

Powder coated, carcass RAL 7035, blue front RAL 5007.

Capacity per shelf in cupboard 30 kg.

5866

As 5864, but instead of the middle shelf 1 lockable keyboard drawer, with full extension and pull-out mouse pad.

Table board with cable slot.

Capacity per shelf in cupboard 30 kg.

5868

As 5864, but with 2 lockable steel cupboards.

Capacity per shelf in cupboards 30 kg.



5862



5864



5866



Example of use



5868



Detailed view keyboard drawer for rolling table 5866.



Blotting pad

For the table board, blue, size 485 x 485 mm.

	Order no.	Capacity kg	Wheel-Ø mm	Outside dimensions W x D x H mm	Net weight kg
Rolling tables	5862	150	125	1120 x 650 x 910	42
	5864	150	125	1120 x 650 x 910	59
	5866	150	125	1120 x 650 x 910	68
	5868	150	125	1120 x 650 x 910	76
Blotting pad	5880	-	-	485 x 485	0,5

C+C CARTS

Saves parking space:

Saves 75 % of space by sliding the unloaded carts into each other.



Surface:

Anti-skid waterproof ply-wood board.



TPE castor:

The innovative easy-running TPE-castor in the attractive fetra design is non-marking and odourless. Particularly smooth-running groove ball bearing.





2960 | 2961 | 2962



Clip board upright DIN A4

See also page 185.



Clip board broadsize DIN A4

See also page 185.



2970 | 2971 | 2972



Wire basket

For small items,
600 x 140 x 200 mm.
See also page 185.



2980 | 2981 | 2982



Deposit locks

Made of high-quality plastic, to be operated easily and safely. Suitable for 1 Euro coins.

Wall securing chain

For deposit lock, length 1.20 m.

Cash and carry carts

Nesting trolleys, thereby reducing storage space by 75%.

Tubular steel construction, powder coated, platform made of anti-skid waterproof plywood boards.

2 swivel and 2 fixed-wheel castors, TPE tyres.

Swivel castors with wheel locks.

2960 | 2961 | 2962

Platform height:
with wheel-Ø 160 = 265 mm
with wheel-Ø 200 = 310 mm

2970 | 2971 | 2972

As 2960/2961/2962, but with 2 shelves.

Shelf heights

with:
wheel-Ø 160 = 265/775 mm

with:
wheel-Ø 200 = 310/820 mm

Capacity upper shelf 80 kg.

2980 | 2981 | 2982

As 2960/2961/2962, but instead of tubular pushbar 2 lateral frames, 680 mm high, on the side of the fixed wheels also 2 lateral frames, 500 mm high.

Platform interior width:
435/535/635 mm

Platform height:
with wheel-Ø 160 = 265 mm
with wheel-Ø 200 = 310 mm

	Order No.	Capacity kg	Wheel-Ø mm	Platform size L x W mm	Outside dimensions L x W x H mm	Net weight kg	
Cash and carry carts	2960	400	160	850 x 500	1045 x 643 x 959	26	
	2961	500	200	1000 x 600	1212 x 743 x 1004	31	
	2962	500	200	1000 x 700	1212 x 843 x 1004	34	
	2970	400	160	850 x 500	1045 x 643 x 959	33	
	2971	500	200	1000 x 600	1212 x 743 x 1004	39	
	2972	500	200	1000 x 700	1212 x 843 x 1004	44	
	2980	400	160	850 x 500	1045 x 643 x 949	28	
	2981	500	200	1000 x 600	1212 x 743 x 990	33	
	2982	500	200	1000 x 700	1212 x 843 x 990	36	
Clip board upright	1290	-	-	-	-	1	
Clip board broadsize	1390	-	-	-	-	1,3	
Wire basket	1291	-	-	-	-	1,8	
Deposit locks	2910	-	-	-	-	0,24	
Wall securing chain	2913	-	-	-	-	0,28	

SHELVED TROLLEYS

Push handle:

Mountable on both sides, also usable without handle.



Variable:

Shelf supports can be individually screwed in a 100 mm grid.



Shelves:

Rigid anti-flex sandwich boards with PVC edging, thereby no open cutting edges. Capacity per shelf 90 kg.



Alternatively with insert boxes:

High-quality workmanship, box height 60 mm, capacity 120 kg per box.





8100 | 8101 | 8102 | 8103



8200 | 8201 | 8202 | 8203



8301 | 8302 | 8303



8240 | 8241 | 8242 | 8243



8341 | 8342 | 8343

Shelved trolleys Modular system

made of tubular and sectional steel, welded and powder coated blue RAL 5007, bolted construction. Ends of tubular construction in 3 heights.

1 fix and 2, 3 or 4 shelves made of special wood material boards, surface beech grain.

Variable use of shelves, in a grid of 100 mm.

Capacity per shelf 90 kg.

2 swivel and 2 fixed-wheel castors, TPE tyres 160 x 40 or 200 x 40 mm, hubs with groove ball bearing.

Swivel castors with wheel locks.

Shelves

Additional charge or price reduction for shelves including 1 pair of support brackets.

Size mm	Order no.
850 x 500	E8100ETAW
1000 x 600	E8101ETAW
1000 x 700	E8102ETAW
1200 x 800	E8103ETAW

Reinforcement struts for shelved trolleys

With flanges for two-point screw attachment.

Stabilises the upper structure and increases the capacity of the inserted shelves.

1 pair per trolley is included.



Capacity per shelf is 150 kg instead of 90 kg.

The shelf located on top of the longitudinal connector struts has a carrying capacity of 150 kg due to the support.

If more shelves need to have an increased capacity, please order reinforcement struts correspondingly.

Reinforcement struts 1 additional pair for 1 shelf

Size mm	Order no.
850 x 500	E8100VK
1000 x 600	E8101VK
1000 x 700	E8102VK
1200 x 800	E8103VK

	Order no.	Capacity kg	Wheel-Ø mm	Platform size L x W mm	Outside dimensions L x W x H mm	Shelf heights mm	Net weight kg
Shelved trolleys	8100	500	160	850 x 500	1019 x 509 x 1111	228, 628, 1028	42
	8101	600	200	1000 x 600	1169 x 609 x 1152	269, 669, 1069	53
	8102	600	200	1000 x 700	1169 x 709 x 1152	269, 669, 1069	58
	8103	600	200	1200 x 800	1369 x 809 x 1152	269, 669, 1069	71
	8200	500	160	850 x 500	1019 x 509 x 1511	228, 628, 1028, 1428	54
	8201	600	200	1000 x 600	1169 x 609 x 1552	269, 669, 1069, 1469	64
	8202	600	200	1000 x 700	1169 x 709 x 1552	269, 669, 1069, 1469	71
	8203	600	200	1200 x 800	1369 x 809 x 1552	269, 669, 1069, 1469	88
	8301	600	200	1000 x 600	1169 x 609 x 1800	269, 669, 1069, 1469	64
	8302	600	200	1000 x 700	1169 x 709 x 1800	269, 669, 1069, 1469	69
	8303	600	200	1200 x 800	1369 x 809 x 1800	269, 669, 1069, 1469	86
	8240	500	160	850 x 500	1019 x 509 x 1511	228, 528, 828, 1128, 1428	57
	8241	600	200	1000 x 600	1169 x 609 x 1552	269, 569, 869, 1169, 1469	74
	8242	600	200	1000 x 700	1169 x 709 x 1552	269, 569, 869, 1169, 1469	82
	8243	600	200	1200 x 800	1369 x 809 x 1552	269, 569, 869, 1169, 1469	102
8341	600	200	1000 x 600	1169 x 609 x 1800	269, 569, 869, 1169, 1469	75	
8342	600	200	1000 x 700	1169 x 709 x 1800	269, 569, 869, 1169, 1469	83	
8343	600	200	1200 x 800	1369 x 809 x 1800	269, 569, 869, 1169, 1469	104	

Accessories
on pages 183-185



Shelved trolleys Modular system

made of tubular and sectional steel, welded and powder coated blue RAL 5007, bolted construction. Ends of tubular construction with intermediate uprights at intervals of approx. 130 mm.

1 fix and 3 or 4 shelves made of special wood material boards, surface beech grain.

Variable use of shelves, in a grid of 100 mm.

Capacity per shelf 90 kg.

2 swivel and 2 fixed-wheel castors, TPE tyres 200 x 40 mm, hubs with groove ball bearing.

Swivel castors with wheel locks.

Shelves

Additional charge or price reduction for shelves including 1 pair of support brackets.

Size mm	Order no.
850 x 500	E8100ETAW
1000 x 600	E8101ETAW
1000 x 700	E8102ETAW
1200 x 800	E8103ETAW

Reinforcement struts for shelved trolleys

1 pair per trolley is included. Details see on page 55.



Capacity per shelf is 150 kg instead of 90 kg.

Reinforcement struts

1 additional pair for 1 shelf

Size mm	Order no.
850 x 500	E8100VK
1000 x 600	E8101VK
1000 x 700	E8102VK
1200 x 800	E8103VK

Accessories
on pages 183-185



8311 | 8312 | 8313



8351 | 8352 | 8353



8311-1 | 8312-1 | 8313-1



8351-1 | 8352-1 | 8353-1



	Order no.	Capacity kg	Wheel-Ø mm	Platform size L x W mm	Outside dimensions L x W x H mm	Shelf heights mm	Net weight kg
Shelved trolleys	8311	600	200	1000 x 600	1169 x 609 x 1800	269, 669, 1069, 1469	73
	8312	600	200	1000 x 700	1169 x 709 x 1800	269, 669, 1069, 1469	83
	8313	600	200	1200 x 800	1369 x 809 x 1800	269, 669, 1069, 1469	98
	8351	600	200	1000 x 600	1169 x 609 x 1800	269, 569, 869, 1169, 1469	82
	8352	600	200	1000 x 700	1169 x 709 x 1800	269, 569, 869, 1169, 1469	94
	8353	600	200	1200 x 800	1369 x 809 x 1800	269, 569, 869, 1169, 1469	115
	8311-1	600	200	1000 x 600	1169 x 630 x 1800	269, 669, 1069, 1469	85
	8312-1	600	200	1000 x 700	1169 x 730 x 1800	269, 669, 1069, 1469	95
	8313-1	600	200	1200 x 800	1369 x 830 x 1800	269, 669, 1069, 1469	114
	8351-1	600	200	1000 x 600	1169 x 630 x 1800	269, 569, 869, 1169, 1469	95
	8352-1	600	200	1000 x 700	1169 x 730 x 1800	269, 569, 869, 1169, 1469	107
	8353-1	600	200	1200 x 800	1369 x 830 x 1800	269, 569, 869, 1169, 1469	128



8120 | 8121 | 8122 | 8123



8220 | 8221 | 8222 | 8223



8321 | 8322 | 8323

Shelved trolleys Modular system

made of tubular and sectional steel, welded and powder coated blue RAL 5007, bolted construction. Ends of tubular construction in 3 heights.

1 fix and 2 or 3 shelves made of special wood material boards, surface beech grain.

Variable use of shelves, in a grid of 100 mm.

Capacity per box 120 kg.

Box height 60 mm.

Interior measure of boxes with platform in mm:

- 850 x 500 = 815 x 455 x 45
- 1000 x 600 = 965 x 555 x 45
- 1000 x 700 = 965 x 655 x 45
- 1200 x 800 = 1165 x 755 x 45

2 swivel and 2 fixed-wheel castors, TPE tyres 160 x 40 or 200 x 40 mm, hubs with groove ball bearing.

Swivel castors with wheel locks.

Boxes for shelved trolleys

Additional charge or price reduction for shelves including 1 pair of support brackets.

Size mm	Order no.
850 x 500	E8120ETAW
1000 x 600	E8121ETAW
1000 x 700	E8122ETAW
1200 x 800	E8123ETAW

Reinforcement struts for shelved trolleys

1 pair per trolley is included.

Details see on page 55.



Capacity per shelf is 150 kg instead of 90 kg.

Reinforcement struts

1 additional pair for 1 shelf

Size mm	Order no.
850 x 500	E8100VK
1000 x 600	E8101VK
1000 x 700	E8102VK
1200 x 800	E8103VK



	Order no.	Capacity kg	Wheel-Ø mm	Platform size L x W mm	Outside dimension L x W x H mm	Shelf heights mm	Net weight kg
Shelved trolleys	8120	500	160	850 x 500	1019 x 509 x 1111	228, 628, 1028	49
	8121	600	200	1000 x 600	1169 x 609 x 1152	269, 669, 1069	62
	8122	600	200	1000 x 700	1169 x 709 x 1152	269, 669, 1069	68
	8123	600	200	1200 x 800	1369 x 809 x 1152	269, 669, 1069	84
	8220	500	160	850 x 500	1019 x 509 x 1511	228, 628, 1028, 1428	58
	8221	600	200	1000 x 600	1169 x 609 x 1552	269, 669, 1069, 1469	73
	8222	600	200	1000 x 700	1169 x 709 x 1552	269, 669, 1069, 1469	81
	8223	600	200	1200 x 800	1369 x 809 x 1552	269, 669, 1069, 1469	100
	8321	600	200	1000 x 600	1169 x 609 x 1800	269, 669, 1069, 1469	74
	8322	600	200	1000 x 700	1169 x 709 x 1800	269, 669, 1069, 1469	82
	8323	600	200	1200 x 800	1369 x 809 x 1800	269, 669, 1069, 1469	101

Accessories on pages 183-185



Shelved trolleys Modular system

Made of tubular and sectional steel, welded and powder coated blue RAL 5007, bolted construction.

1 fix and 3 shelves made of special wood material boards, surface beech grain.

Variable use of shelves, in a grid of 100 mm.

Capacity per shelf 90 kg.

2 swivel and 2 fixed-wheel castors, TPE tyres 200 x 40 mm, hubs with groove ball bearing.

Swivel castors with wheel locks.

8411 | 8412 | 8413

End panels closed, made of wire lattice 100 x 100 x 5 mm.

8411-1 | 8412-1 | 8413-1

Ends and sides closed, made of wire lattice 100 x 100 x 5 mm.

8481-3DE | 8482-3DE |

8483-3DE

8581-3DE | 8582-3DE |

8583-3DE

Ends, side, roof and double wing door closed with wire lattice 100 x 100 x 5 mm.

In frame of door integrated bolt lock, lockable with padlock (not included in delivery), wing doors turnable till side panels.

Shelves

Additional charge or price reduction for shelves including 1 pair of support brackets.

Size mm	Order no.
1000 x 600	E8101ETAW
1000 x 700	E8102ETAW
1200 x 800	E8103ETAW

Reinforcement struts for shelved trolleys

Capacity per shelf is 150 kg instead of 90 kg.

Reinforcement struts

1 additional pair for 1 shelf

Size mm	Order no.
1000 x 600	E8101VK
1000 x 700	E8102VK
1200 x 800	E8103VK

Accessories on pages 183-185



8411 | 8412 | 8413



8411-1 | 8412-1 | 8413-1



8481-3DE | 8482-3DE | 8483-3DE



8581-3DE | 8582-3DE | 8583-3DE



Roof

Made of tubular steel frame with wire lattice 100 x 100 x 5 mm, powder coated.



Bolt lock

Integrated bolt lock, doors lockable with padlock.

	Order no.	Capacity kg	Wheel-Ø mm	Platform size L x W mm	Outside dimensions L x W x H mm	Shelf heights mm	Net weight kg
Shelved trolleys with side panels made of wire lattice	8411	600	200	1000 x 600	1169 x 609 x 1800	269, 669, 1069, 1469	74
	8412	600	200	1000 x 700	1169 x 709 x 1800	269, 669, 1069, 1469	79
	8413	600	200	1200 x 800	1369 x 809 x 1800	269, 669, 1069, 1469	97
	8411-1	600	200	1000 x 600	1169 x 609 x 1800	269, 669, 1069, 1469	82
	8412-1	600	200	1000 x 700	1169 x 709 x 1800	269, 669, 1069, 1469	85
	8413-1	600	200	1200 x 800	1369 x 809 x 1800	269, 669, 1069, 1469	103
Shelved trolleys with doors and roof	8481-3DE	600	200	1000 x 600	1169 x 630 x 1552	269, 669, 1069	77,8
	8482-3DE	600	200	1000 x 700	1169 x 730 x 1552	269, 669, 1069	83,7
	8483-3DE	600	200	1200 x 800	1369 x 830 x 1552	269, 669, 1069	106
Shelved trolleys with doors and roof	8581-3DE	600	200	1000 x 600	1169 x 630 x 1800	269, 569, 869, 1169, 1469	104
	8582-3DE	600	200	1000 x 700	1169 x 730 x 1800	269, 569, 869, 1169, 1469	115
	8583-3DE	600	200	1200 x 800	1369 x 830 x 1800	269, 569, 869, 1169, 1469	140

PARCEL CARTS

Push handle:

Mountable on both sides, also usable without handle.

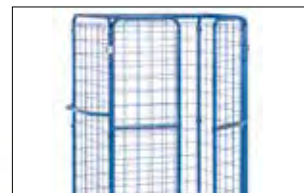
**Many versions:**

Available with open longitudinal side, with double wing door, with roof.

**Inserts:**

Made of wire lattice or tubular steel.

**TPE castor:**

The innovative easy-running TPE-castor in the attractive fetra design is non-marking and odourless. Particularly smooth-running groove ball bearing.



Parcel cart **8582-1**



Parcel carts Modular system

made of tubular and sectional steel, welded and powder coated blue RAL 5007, bolted construction.

Ends of tubular construction in 2 heights with intermediate uprights at intervals of approx. 130 mm or with ends and sides made of wire lattice 100 x 100 x 5 mm.

8381-1 | 8382-1 | 8383-1 with detachable side panels.

Platform made of special wood material boards, surface beech grain.

2 swivel and 2 fixed-wheel castors, TPE tyres 200 x 40 mm, hubs with groove ball bearing.

Swivel castors with wheel locks.

Total height/Useful height
1552 mm/1280 mm
1800 mm/1530 mm



8481-1 | 8482-1 | 8483-1



8581-1 | 8582-1 | 8583-1



8381-1 | 8382-1 | 8383-1

Shelves

Additional charge or price reduction for shelves including 1 pair of support brackets.

Size mm	Order no.
1000 x 600	E8101ETAW
1000 x 700	E8102ETAW
1200 x 800	E8103ETAW

Accessories
on pages 183-185

	Order no.	Capacity kg	Wheel-Ø mm	Platform size L x W mm	Outside dimensions L x W x H mm	Shelf heights mm	Net weight kg
Parcel carts	8481-1	600	200	1000 x 600	1169 x 609 x 1552	269	44
	8482-1	600	200	1000 x 700	1169 x 709 x 1552	269	49
	8483-1	600	200	1200 x 800	1369 x 809 x 1552	269	55
	8581-1	600	200	1000 x 600	1169 x 609 x 1800	269	46
	8582-1	600	200	1000 x 700	1169 x 709 x 1800	269	49
	8583-1	600	200	1200 x 800	1369 x 809 x 1800	269	58
	8381-1	600	200	1000 x 600	1169 x 630 x 1800	269	58
	8382-1	600	200	1000 x 700	1169 x 730 x 1800	269	63
	8383-1	600	200	1200 x 800	1369 x 830 x 1800	269	70

Parcel carts

Modular system

8481-3 | 8482-3 | 8483-3
8581-3 | 8582-3 | 8583-3

with end and sides made of wire lattice. Made of tubular and sectional steel, welded and powder coated blue RAL 5007, bolted construction.

Ends and sides made of wire lattice 100 x 100 x 5 mm.

With double wing doors at the open side panel.

Tubular steel frame with wire lattice 100 x 100 x 5 mm.

Integrated bolt lock, doors lockable with padlock (not included in delivery), wing doors turnable till side panels.

Platform made of special wood material boards, surface beech grain.

2 swivel and 2 fixed-wheel castors, TPE tyres 200 x 40 mm, hubs with groove ball bearing.

Swivel castors with wheel locks.

Total height/ Useful height
1552 mm / 1280 mm
1800 mm / 1530 mm

8481-3D | 8482-3D
8483-3D | 8581-3D
8582-3D | 8583-3D

Construction as above, but additionally with roof made of wire lattice.

Shelves

Additional charge or price reduction for shelves including 1 pair of support brackets.

Size mm	Order no.
1000 x 600	E8101ETAW
1000 x 700	E8102ETAW
1200 x 800	E8103ETAW

Accessories

on pages 183-185



8481-3 | 8482-3 | 8483-3



8481-3D | 8482-3D | 8483-3D



8581-3 | 8582-3 | 8583-3



8581-3D | 8582-3D | 8583-3D



Roof

Made of tubular steel frame with wire lattice 100 x 100 x 5 mm, powder coated.

	Order no.	Capacity kg	Wheel-Ø mm	Platform size LxW mm	Outside dimensions LxWxH mm	Shelf heights mm	Net weight kg
Parcel carts with double wing doors	8481-3	600	200	1000 x 600	1169 x 630 x 1552	269	58
	8482-3	600	200	1000 x 700	1169 x 730 x 1552	269	61
	8483-3	600	200	1200 x 800	1369 x 830 x 1552	269	65,5
	8581-3	600	200	1000 x 600	1169 x 630 x 1800	269	62
	8582-3	600	200	1000 x 700	1169 x 730 x 1800	269	63
	8583-3	600	200	1200 x 800	1369 x 830 x 1800	269	70,5
Parcel carts with double wing doors and roof	8481-3D	600	200	1000 x 600	1169 x 630 x 1552	269	60,5
	8482-3D	600	200	1000 x 700	1169 x 730 x 1552	269	63,5
	8483-3D	600	200	1200 x 800	1369 x 830 x 1552	269	75
	8581-3D	600	200	1000 x 600	1169 x 630 x 1800	269	65
	8582-3D	600	200	1000 x 700	1169 x 730 x 1800	269	67,5
	8583-3D	600	200	1200 x 800	1369 x 830 x 1800	269	79

SHELVED TROLLEYS WITH DETACHABLE SHELVES



Patented Insert-and-Bolt principle:
Shelves can be inserted into a 120 mm grid, either horizontally or at an incline of 15° or 30°. Easily installed without tools by one person.



Shelves:
With 15 mm high rim made of angle steel on the longitudinal sides.



TPE castor:
The innovative easy-running TPE-castor in the attractive fetra design is non-marking and odourless. Particularly smooth-running groove ball bearing.



Alternatively with wire lattice:
Permeable and insensitive to dirt.





4295 | 4296



4255 | 4256



4395 | 4396



4495 | 4496

Shelved trolleys with detachable shelves

with horizontal or inclined, detachable shelves.

Tubular/sectional steel design, powder coated.

Fixed and detachable shelves made of derived timber material boards, surface beech gain, put into an angle steel frame with 15 mm high skirting at both sides. Detachable shelves variably insertable, distance between support rods 120 mm. Possible angle when inclined 15° or 30°.

2 swivel and 2 fixed-wheel castors, TPE tyres 200 x 40 mm, hubs with groove ball bearing.

Swivel castors with wheel locks.

Capacity per shelf 80 kg.

German Patent 102 55 281

4495 | 4496

as above, but with fixed and detachable shelves with welded wire lattice 140 x 40 mm, powder coated blue RAL 5007.

Capacity per shelf 50 kg.



	Order no.	Capacity kg	Wheel-Ø mm	Platform size L x W mm	Outside dimensions L x W x H mm	No. of shelves	Net weight kg	Add. shelves	
								Order no.	
Shelved trolleys	4295	500	200	1250 x 610	1430 x 620 x 1560	3	68	E4195ET	
	4296	500	200	1650 x 610	1830 x 620 x 1560	3	85	E4196ET	
	4255	500	200	1250 x 610	1430 x 620 x 1560	4	83	E4195ET	
	4256	500	200	1650 x 610	1830 x 620 x 1560	4	105	E4196ET	
	4395	500	200	1250 x 610	1430 x 620 x 1800	4	86	E4195ET	
	4396	500	200	1650 x 610	1830 x 620 x 1800	4	108	E4196ET	
	4495	500	200	1250 x 610	1430 x 620 x 1800	4	73	E4495ET	
	4496	500	200	1650 x 610	1830 x 620 x 1800	4	87	E4496ET	

Accessories on pages 183-185

ESD TRANSPORT EQUIPMENT

Electrically conductive:

Prevents high-value products from being damaged by electrostatic discharge.

Surface:

Electrically conductive wood composite board according to DIN 68765, light grey.



Powder coating:

Surface shot-blasted and powder-coated conductive, slate grey RAL 7015.

TPE-ESD castors:

Excellent electrical conductivity, wheels with TPE-ESD tyres. Non-marking and odourless.





B9116V



B9125V



B9331V



1820



9500 | 9501 | 9502 | 9503

ESD-Tubular steel trucks
B9116V | B9125V |
B9331V

Electric static discharge construction (ESD = Electrostatic Discharge). Handy tubular steel trucks with steel sheet blades, sturdy welded construction, conductive powder coating, slate grey, RAL 7015. Safety grips. Steel sheet front shovel mountable, therefore exchangeable. ESD-Solid rubber tyres on synthetic rims, hubs with roller bearings. Bar and transversal struts.

ESD-Dolly with gooseneck handle 1820

made of tubular steel welded, handle bolted on. Capacity of upper shelf 100 kg.

ESD-Open carts
9500 | 9501 | 9502 | 9503

Electric static discharge construction (ESD = Electrostatic Discharge). Tubular steel and sectional steel welded, conductive powder coating, slate grey, RAL 7015. Screw and plug type construction. Shelves made of electrically conductive wood material according to DIN 68765, light grey.

2 swivel and 2 fixed-wheel castors with TPE-ESD tyres (thermoplastic elastomer), electrically conductive. Hubs with precision groove ball bearing. Castors with wheel lock.

Maximum comfort: Very low starting, rolling and swivelling resistance. Low noise operation on level floors. Tyres are non-marking.

	Order no.	Capacity kg	Height mm	Blade depth mm	Blade width mm	Total width mm	Solid rubber tyres mm	Net weight kg
ESD-Tubular steel trucks	B9116V	250	1150	300	480	590	260 x 56	18
	B9125V	200	1150	250	320	570	260 x 56	14
	B9331V	300	1300	300	480	580	260 x 56	20

	Order no.	Capacity kg	Wheel-Ø mm	Platform size L x W mm	Outside dimensions L x W x H mm	Shelf heights mm	Net weight kg
ESD-Dolly	1820	250	125	600 x 450	860 x 450 x 875	195, 770	15
ESD-Open carts	9500	500	160	850 x 500	970 x 509 x 950	235	24
	9501	600	200	1000 x 600	1120 x 609 x 990	276	30
	9502	600	200	1000 x 700	1120 x 709 x 990	276	33
	9503	600	200	1200 x 800	1320 x 809 x 990	276	38



Accessories
on pages 183-185



ESD-Trolleys

Electric static discharge construction (ESD = Electrostatic Discharge).

Tubular steel and sectional steel welded, conductive powder coating, slate grey, RAL 7015. Screw and plug type construction.

Shelves made of electrically conductive wood material according to DIN 68765, light grey.

2 swivel and 2 fixed-wheel castors with TPE-ESD tyres (thermoplastic elastomer), electrically conductive.

Hubs with precision groove ball bearing. Castors with wheel lock.

Maximum comfort: Very low starting, rolling and swivelling resistance. Low noise operation on level floors. Tyres are non-marking.

ESD-Table top carts

1840 - 1851

Shelves with 5 mm high rim.

Capacity of upper and middle shelves 80 kg.



1840 | 1841



1850 | 1851



9496



9400 | 9401 | 9402 | 9403

ESD-Table top carts

9496

Square platform 600 x 600 mm. Shelves made of wood material flush with frame, powder coated.

Capacity upper shelf 200 kg.

ESD-Table top carts

9400 | 9401 | 9402 | 9403

Shelves made of wood material flush with frame, powder coated.

Capacity upper shelf 200 kg.



Example of use



	Order no.	Capacity kg	Wheel-Ø mm	Platform size L x W mm	Outside dimensions L x W x H mm	No. of shelves	Shelf heights mm	Net weight kg
ESD-table top carts	1840	300	125	850 x 500	986 x 511 x 1039	2	206, 827	30
	1841	300	125	1000 x 600	1136 x 611 x 1039	2	206, 827	39
	1850	300	125	850 x 500	986 x 511 x 1039	3	206, 517, 827	39
	1851	300	125	1000 x 600	1136 x 611 x 1039	3	206, 517, 827	54
ESD-table top carts	9496	500	160	600 x 600	737 x 609 x 867	2	235, 867	34
	9400	500	160	850 x 500	1047 x 509 x 867	2	235, 867	38
	9401	600	200	1000 x 600	1197 x 609 x 908	2	276, 908	47
	9402	600	200	1000 x 700	1197 x 709 x 908	2	276, 908	52
	9403	600	200	1200 x 800	1397 x 809 x 908	2	276, 908	61

Accessories

on pages 183-185



9496B



9400B | 9401B | 9402B | 9403B



9496W



9400W | 9401W | 9402W | 9403W



ESD-Table top carts

Electric static discharge construction (ESD = Electrostatic Discharge).

Tubular steel and sectional steel welded, shelves made of steel sheet flush oder with rim, conductive powder coating, slate grey, RAL 7015. Screw and plug type construction.

2 swivel and 2 fixed-wheel castors with TPE-ESD tyres (thermoplastic elastomer), electrically conductive. Hubs with precision groove ball bearing. Castors with wheel lock.

Maximum comfort: Very low starting, rolling and swivelling resistance. Low noise operation on level floors. Tyres are non-marking.

Capacity upper shelf 200 kg.

9496B

Square platforms, shelves steel sheet flush with frame, neatly welded, powder coated.

9400B | 9401B | 9402B | 9403B

Rectangular platforms, shelves steel sheet flush with frame, neatly welded, powder coated.

9496W

Square platforms, shelves steel sheet trays with 10 mm high rim, welded oil-tight, powder coated.

9400W | 9401W | 9402W | 9403W

Rectangular platforms, shelves steel sheet trays with 10 mm high rim, welded oil-tight, powder coated.

	Order no.	Capacity kg	Wheel-Ø mm	Platform size LxW mm	Outside dimensions LxW x H mm	No. of shelves	Shelf heights mm	Net weight kg
ESD-Table top carts with steel sheet platform	9496B	500	160	600 x 600	737 x 609 x 867	2	228, 860	42
	9400B	500	160	850 x 500	1047 x 509 x 867	2	228, 860	45
	9401B	600	200	1000 x 600	1197 x 609 x 908	2	270, 900	56
	9402B	600	200	1000 x 700	1197 x 709 x 908	2	270, 900	61
	9403B	600	200	1200 x 800	1397 x 809 x 908	2	270, 900	78
ESD-Table top carts with steel sheet trays	9496W	500	160	600 x 600	737 x 609 x 867	2	228, 860	38
	9400W	500	160	850 x 500	1047 x 509 x 867	2	228, 860	40
	9401W	600	200	1000 x 600	1197 x 609 x 908	2	270, 900	50
	9402W	600	200	1000 x 700	1197 x 709 x 908	2	270, 900	54
	9403W	600	200	1200 x 800	1397 x 809 x 908	2	270, 900	65

Accessories on pages 183-185



ESD-Shelved trolleys

Electric static discharge construction (ESD = Electrostatic Discharge).

Tubular steel and sectional steel welded, conductive powder coating, slate grey, RAL 7015. Screw and plug type construction. Shelves made of electrical-conductive wood material according to DIN 68765, light grey.

Wheels electrically conductive (anti-static) with TPE-ESD tyres (thermoplastic elastomer).

Hubs with precision deep groove ball bearing.

Castors with wheel lock.

Capacity per shelf 50 kg.

ESD-Shelves

Additional charge or price reduction for shelves including 1 pair of support brackets.

Size mm	Order no.
850 x 500	E9100ETAW
1000 x 600	E9101ETAW
1000 x 700	E9302ETAW
1200 x 800	E9303ETAW

Reinforcement struts for shelved trolleys

1 pair per trolley is included.



Capacity per shelf is 110 kg instead of 50 kg.

Reinforcement struts 1 additional pair for 1 shelf

Size mm	Order no.
850 x 500	E9100VK
1000 x 600	E9101VK
1000 x 700	E9102VK
1200 x 800	E9103VK

ESD-Ends made of wire lattice

Available on request.

All shelved trolleys can be equipped with ends made of wire lattice (see page 58 shelved trolleys).

a) both ends made of wire lattice 100 x 100 x 5 mm.

b) both ends and one side panel made of wire lattice 100 x 100 x 5 mm.

Accessories
on pages 183-185



9100 | 9101



9200 | 9201



9301 | 9302 | 9303



9341 | 9342 | 9343



	Order no.	Capacity kg	Wheel-Ø mm	Platform size L x W mm	Outside dimensions L x W x H mm	No. of shelves	Shelf heights mm	Net weight kg
ESD-shelved trolleys	9100	500	160	850 x 500	1019 x 509 x 1111	3	235, 635, 1035	42
	9101	600	200	1000 x 600	1169 x 609 x 1152	3	276, 676, 1076	57
	9200	500	160	850 x 500	1019 x 509 x 1511	4	235, 635, 1035, 1435	48
	9201	600	200	1000 x 600	1169 x 609 x 1552	4	276, 676, 1076, 1476	65
	9301	600	200	1000 x 600	1169 x 609 x 1800	4	276, 676, 1076, 1476	66
	9302	600	200	1000 x 700	1169 x 709 x 1800	4	276, 676, 1076, 1476	73
	9303	600	200	1200 x 800	1369 x 809 x 1800	4	276, 676, 1076, 1476	106
	9341	600	200	1000 x 600	1169 x 609 x 1800	5	276, 576, 876, 1176, 1476	72
	9342	600	200	1000 x 700	1169 x 709 x 1800	5	276, 576, 876, 1176, 1476	84
	9343	600	200	1200 x 800	1369 x 809 x 1800	5	276, 576, 876, 1176, 1476	121



9392 | 9393



Vertical locking rod with turning lever and cylinder lock.



TOTALSTOP - the fetra central brake system
With only one foot the rotation of wheels and the swivelling movement of both swivel castors can be securely locked. The brake pedal is always visible to the operator.
Standard with TOTALSTOP.

ESD-Box carts
9392 | 9393

Electric static discharge construction (ESD = Electrostatic Discharge).

Angle steel construction with tubular handlebar. conductive powder coating, slate grey, RAL 7015. Ends, 1 side and top fitted with wire lattice 40 x 40 x 4 mm, completely welded and powder coated. 1 fixed and 4 detachable wood material shelves, surface beech grain. 2 swivel and 2 fixed-wheel castors with electrically conductive (anti-static) TPE-ESD tyres (thermoplastic elastomer). hubs with groove ball bearing.

TOTALSTOP central braking system standard on swivel castors.

Delivery includes 4 shelves. Clearance between shelves 280 mm.

Variable use of shelves, in a grid of 100 mm.

Capacity per shelf 50 kg.

ESD-Pallet dollies

23799 | 23800 | 23801 | 23802

Pallet dollies for pallets and lattice boxes. Sturdy sectional steel construction with 4 catch corners for stacking.

ESD-Mobile tilting stands 1890*

For plastic boxes, steel plate boxes, wire baskets etc., adjustable in height and mobile.

Sectional steel-/ tubular construction with steel plate platform. Steel plate platform with all side rim, 20 mm high. Not inclinable, adjustable in height in intervals of 25 mm.

4 swivel castors with TPE-ESD tyres, hubs groove ball bearing, 2 wheels with locks.

1891* | 1892*

Steel plate platform with single-sided lay-on edge, straight or inclinable by 15° und 30°, adjustable in height in intervals of 25 mm.

*Can not be fitted with TOTALSTOP or FIXSTOP.

Accessories
on pages 183-185



23799 | 23800 | 23801 | 23802



1890*



1891* | 1892*

	Order no.	Capacity kg	Wheel-Ø mm	Platform size L x W mm	Shelf heights mm	Net weight kg
ESD-box carts	9392	750	200	1000 x 680	292, 582, 882, 1182, 1482	144
	9393	750	200	1200 x 780	292, 582, 882, 1182, 1482	175

	Order no.	Capacity kg	Wheel-Ø mm	Platform size L x W mm	For pallet size L x W mm	Height mm	Net weight kg
ESD-pallet dollies	23799	750	200	810 x 610	800 x 600	282	30
	23800	750	200	1010 x 810	1000 x 800	282	33
	23801	750	200	1210 x 810	1200 x 800	282	34
	23802	750	200	1210 x 1010	1200 x 1000	282	35

	Order no.	Capacity kg	Wheel-Ø mm	Platform size L x W mm	Shelf heights mm	Net weight kg
ESD-mobile tilting stand*	1890	150	75	605 x 405	720 – 995	17
	1891	150	75	510 x 410	500 – 775	18
	1892	150	75	510 x 410	755 – 1105	18



ESD-Rollers | ESD-Trolleys

Electric static discharge construction (ESD = Electrostatic Discharge).

Tubular steel and sectional steel welded, conductive powder coating, slate grey, RAL 7015.

Shelves made of electrically conductive wood material according to DIN 68765, light grey.

Wheels electrically conductive (anti-static) with TPE-ESD tyres (thermoplastic elastomer). Hubs with precision deep groove ball bearing. Castors with wheel lock.

ESD-Euro box rollers

Suitable for euro boxes 600 x 400 mm, 4 swivel castors. 2 with wheel lock.

93580

Open angle steel construction.

93581

Angle steel construction with platform made of electrically conductive (anti-static) HPL composite, rim 7 mm high.

93540

With 2 platforms with shelves made of electrically conductive (anti-static) wood material, rim 7 mm high. Clearance between platforms 400 mm. Capacity upper shelf 100 kg.

935400

As 93540, but with tubular push bar.

ESD-Storage trolleys

Tubular steel and steel section construction. 2 swivel and 2 fixed-wheel castors, swivel castors with wheel locks.

Capacity upper and middle shelves 50 kg.

92900 | 92910

Open frames without board.

92910 | 92911

With tiltable platforms. Upper and middle platforms tiltable to both sides by 15° and 30°, locked by spring catch.

92901 | 92911

With 3 electrically conductive (anti-static) HPL composite shelves, rim 7 mm high.



93580



93581



93540



935400



92900



92901



92910



92911

	Order no.	Capacity kg	Wheel-Ø mm	Platform size L x W mm	Outside dimensions L x W x H mm	Loading heights mm	Net weight kg
ESD-euro box rollers	93580	250	125	605 x 405	610 x 415 x 209	182	9
	93581	250	125	605 x 405	610 x 415 x 209	201	12
	93540	250	125	605 x 405	676 x 415 x 639	201, 630	21
	935400	250	125	605 x 405	746 x 415 x 970	201, 630	22
ESD-storage trolleys	92900	200	125	605 x 405	821 x 455 x 1178	197, 652, 1152	23
	92901	200	125	605 x 405	821 x 455 x 1178	216, 671, 1171	33
	92910	200	125	605 x 405	821 x 455 x 1178	197, 652, 1152	26
	92911	200	125	605 x 405	821 x 455 x 1178	216, 671, 1171	36



9380



9381



9390



9391



9383



9384

ESD-Euro box carts

Electric static discharge construction (ESD = Electrostatic Discharge).

Tubular steel and sectional steel welded, conductive powder coating, slate grey, RAL 7015.

Shelves made of electrically conductive wood material according to DIN 68765, light grey.

Wheels electrically conductive (anti-static) with TPE-ESD tyres (thermoplastic elastomer). Hubs with precision deep groove ball bearing. Castors with wheel lock.

9380 | 9390

3 shelf frames for 1 or 2 Euro boxes each 600 x 400 mm.

Variable use of shelf frames, distance 50 mm, angle when inclined up to 15° and 30°.

Capacity per shelf 80 kg.

9381 | 9391

as 9380 | 9390, but with 3 platforms with shelves made of electrically conductive (anti-static) wood material, rim 7 mm high.

9383

5 shelf frames for 3 Euro boxes each 600 x 400 mm.

Variable use of shelf frames, distance 50 mm, angle when inclined up to 15° and 30°.

Capacity per shelf 80 kg.

9384

As 9383, but with 5 platforms with shelves made of electrical-conductive (anti-static) HPL composite, rim 7 mm high.

9381 | 9391 | 9384

Rim 7 mm high.

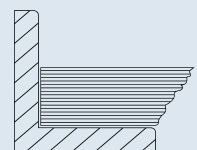

	Order no.	Capacity kg	Wheel-Ø mm	Platform size L x W mm	Outside dimensions L x W x H mm	Loading heights mm	Net weight kg
ESD-euro box carts	9380	250	125	410 x 610	525 x 666 x 1101	238, 538, 838	31
	9381	250	125	410 x 610	525 x 666 x 1101	257, 557, 857	41
	9390	250	125	820 x 610	935 x 666 x 1101	238, 538, 838	38
	9391	250	125	820 x 610	935 x 666 x 1101	257, 557, 857	55
	9383	400	160	1240 x 610	1372 x 685 x 1686	298, 598, 898, 1198, 1498	73
	9384	400	160	1240 x 610	1372 x 685 x 1686	317, 617, 917, 1217, 1517	123

OFFICE TROLLEYS

Clean design:

Powder coated in light grey RAL 7035, shelves and panels made of derived timber board material, pale grey.



4 large quality swivel castors:

For smooth running and optimal manoeuvrability. 2 with total locking brakes.

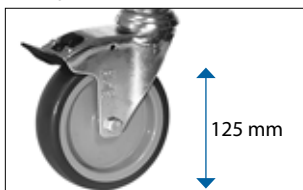

Wheels with pneumatic tyres:

Optionally available for uneven floors.





4870



4871



4872



4873



4878

Office trolleys

in a bolted, tubular steel construction, powder coated light grey RAL 7035. Shelves and panels made of derived material timber board, pale grey.

4 swivel castors, pneumatic tyres 125 x 32 mm, hubs with roller bearings, trackless.

2 tyres with wheel locks.

Flat packed for easy self assembly.

Capacity per shelf 50 kg.

4871

With longitudinal wall (back wall).

4872

With separating plate.

4873

With separating plate and longitudinal wall (back wall).

4878

With 2 separating plates and longitudinal wall (back wall).

Wheels with pneumatic tyres

150 x 30 mm, tyres blue-grey „trackless“

Order no. 5097

Shelf heights increase + 20 mm

	Order no.	Capacity kg	Wheel-Ø mm	Platform size L x W mm	Outside dimensions L x W x H mm	Shelf heights mm	Net weight kg
Office trolleys	4870	150	125	720 x 350	810 x 385 x 1100	260, 620, 980	22
	4871	150	125	720 x 350	810 x 385 x 1100	260, 620, 980	25
	4872	150	125	720 x 350	810 x 385 x 1100	260, 620, 980	23
	4873	150	125	720 x 350	810 x 385 x 1100	260, 620, 980	26
	4878	150	125	1080 x 350	1165 x 385 x 1100	260, 620, 980	34



Office trolleys

in a bolted tubular steel construction, powder coated light grey RAL 7035. Shelves and panels made of derived material timber board, pale grey.

4 swivel castors, pneumatic tyres 125 x 32 mm, hubs with roller bearings, trackless .

2 tyres with wheel lock.

Flat packed for easy self assembly.

4880 | 4882

Capacity per shelf 50 kg.



4880



4882

4891

with shelves inclined to the rear. Back wall in a right angle to the shelf.

Inclination approx. 27 mm.

Capacity per shelf 50 kg.

With back wall.

Wheels with pneumatic tyres

150 x 30 mm, tyres blue-grey „trackless“

Order no. 5097

Shelf heights increase +20 mm



4891



Example of use

	Order no.	Capacity kg	Wheel-Ø mm	Platform size L x W mm	Outside dimensions L x W x H mm	Shelf heights mm	Net weight kg
Office trolleys	4880	150	125	800 x 500	900 x 535 x 925	260, 800	19
	4882	150	125	800 x 500	900 x 535 x 925	260, 530, 800	24
	4891	150	125	770 x 320	855 x 400 x 1218	246, 606, 1016	31

STAINLESS STEEL TROLLEYS

For best hygiene:

Push handles and shelves made of stainless steel. Rustproof castors according to DIN 18867 part 8.

High-quality shelves:

Deep-drawn shelves with all-round skirting, lined for sound reduction.



4 large quality swivel castors:

For smooth running and optimal manoeuvrability. 2 with total locking brakes.



Edge protection:

Protective wheels and edge protection corners prevent bumping damage.



Stainless steel trolleys

Shelved trolley (tea-cart) with tubular push bar made of CNS (chrome-nickel steel) and deep-drawn shelves made of CS (chrome steel), with all-round skirting, lined for sound reduction. Protective edges and wheels.

Rustproof wheels according to DIN 18867 part 8.

4 swivel castors with TPE-wheels 125 x 32 mm, elastic and easy running, trackless. Hubs with ball bearings, 2 swivel castors with wheel locks.

Flat packed for easy self assembly.

Capacity per shelf 80 kg.

Wheels with pneumatic tyres

150 x 30 mm, tyres blue-grey „trackless“

Order no. 5098

Shelf heights increase +20 mm



5036



5038



5001 | 5011 | 5017



5005 | 5013 | 5019

	Order no.	Capacity kg	Wheel-Ø mm	No. of shelves	Platform size L x W mm	Outside dimensions L x W x H mm	Clearance between shelves mm	Shelf heights mm	Net weight kg
Stainless steel trolleys	5036	120	125	2	630 x 400	700 x 470 x 950	585	230, 850	12
	5038	150	125	3	630 x 400	700 x 470 x 950	275	230, 540, 850	14,5
	5001	120	125	2	800 x 500	870 x 570 x 950	585	230, 850	15
	5011	120	125	2	1000 x 500	1070 x 570 x 950	585	230, 850	16
	5017	120	125	2	1000 x 600	1070 x 670 x 950	585	230, 850	17
	5005	150	125	3	800 x 500	870 x 570 x 950	275	230, 540, 850	17
	5013	150	125	3	1000 x 500	1070 x 570 x 950	275	230, 540, 850	19
	5019	150	125	3	1000 x 600	1070 x 670 x 950	275	230, 540, 850	22

BOX CARTS

Safe and stable:

Small-meshed wire lattice 40 x 40 x 4 mm. This results in significantly enhanced stability and higher access safety compared to the usual mesh size 50 x 50 x 4 mm.



Vertical locking rod:

With sleek turning lever and cylinder lock.

Many versions:

Also available with steel sheet, aluminium sheet and transparent plastic.

TPE castor:

The innovative easy-running TPE-castor in the attractive fetra design is non-marking and odourless. Particularly smooth-running groove ball bearing.



TOTALSTOP-central brake system:

Apart from the rotation of the wheels, also the swivelling movement of both swivel castors is securely locked with only one push by foot.
European Patent EP 2743097





Box carts

Tubular steel and profile steel welded, powder coated blue RAL 5007. Platform made of derived timber material board, surface beech grain.

2 swivel and 2 fixed-wheel castors, TPE tyres, hubs with groove ball bearing. Swivel castors with wheel locks.

Wire cage carts

2772 | 2773

with tubular steel superstructure, wire lattice 50 x 50 x 4 mm, welded. Bolted modular version, powder coated.

Useful height: 700 mm

Flat packed delivery.



2772 | 2773



2762 | 2763

Wire cage carts with cover

2762 | 2763

with angular steel superstructure, wire lattice 50 x 50 x 4 mm, welded. Cover double collapsible. Ring-eyelets for padlocks.

Useful height: 806 mm



2872 | 2873



2852 | 2853

Wooden box carts

2872 | 2873

as 2772 | 2773, but all sides of derived timber material boards, surface beech grain.

Flat packed delivery.

Wooden box carts with cover

2852 | 2853

as 2762 | 2763, but sides and cover made of derived timber material boards, surface beech grain.

	Order no.	Capacity kg	Wheel-Ø mm	Platform size L x W mm	Outside dimensions L x W x H mm	Net weight kg	
Wire cage carts	2772	600	200	1000 x 700	1060 x 715 x 1069	51	
	2773	600	200	1200 x 800	1260 x 815 x 1069	60	
Wire cage carts with cover	2762	600	200	1000 x 700	1130 x 725 x 1113	70	
	2763	600	200	1200 x 800	1330 x 825 x 1113	82	
Wooden box carts	2872	600	200	1000 x 700	1060 x 715 x 1069	64	
	2873	600	200	1200 x 800	1260 x 815 x 1069	76	
Wooden box carts with cover	2852	600	200	1000 x 700	1130 x 725 x 1113	90	
	2853	600	200	1200 x 800	1330 x 825 x 1113	105	

Accessories

on pages 183-185



2842 | 2843



2862 | 2863



2822 | 2823



2832 | 2833

Sheet steel box carts

Tubular steel and profile steel welded, powder coated blue RAL 5007. Platforms made of sheet steel, powder coated or galvanized.

2 swivel and 2 fixed-wheel castors, TPE tyres, hubs with deep groove ball bearing. Swivel castors with wheel locks.

Sheet steel box carts

2842 | 2843

angle steel construction, sides made of sheet steel, welded and powder coated.

Useful height: 816 mm

Sheet steel box carts with cover

2862 | 2863

Construction as 2842 | 2843, but with one-piece cover, to be opened by means of gas pressure spring, ring eyelets for padlocks.

Sheet steel box carts

2822 | 2823

Construction as 2842 | 2843, but with sides of galvanized steel plates, glued in place.

Useful height: 816 mm

Sheet steel box carts with cover

2832 | 2833

Construction as 2822 | 2823, but with one-piece cover as with 2862 | 2863.

	Order no.	Capacity kg	Wheel-Ø mm	Platform size L x W mm	Outside dimensions L x W x H mm	Net weight kg	
Sheet steel box carts	2842	600	200	1000 x 700	1130 x 725 x 1069	83	
	2843	600	200	1200 x 800	1330 x 825 x 1069	95	
Sheet steel box carts with cover	2862	600	200	1000 x 700	1150 x 730 x 1113	95	
	2863	600	200	1200 x 800	1350 x 830 x 1113	114	
Sheet steel box carts	2822	600	200	1000 x 700	1130 x 725 x 1069	69	
	2823	600	200	1200 x 800	1330 x 825 x 1069	80	
Sheet steel box carts with cover	2832	600	200	1000 x 700	1150 x 730 x 1113	80	
	2833	600	200	1200 x 800	1350 x 830 x 1113	93	



Box carts

in angle steel construction with tubular handlebar. Ends, 1 side and top fitted with wire lattice 40 x 40 x 4 mm, completely welded and powder coated. 1 fixed and 4 detachable wood material shelves, surface beech grain.

2 swivel and 2 fixed-wheel castors with TPE tyres (thermo-plastic elastomer), hubs with groove ball bearing.

TOTALSTOP central braking system standard on swivel castors.

Maximum comfort: Very low starting, rolling and swivelling resistance. Low noise operation on level floors. Tyres are non-marking (trackless).

Delivery includes 4 shelves.

Shelf heights:

292, 582, 882, 1182, 1482 mm

Clearance between shelves 280 mm.

Variable use of shelves, in a grid of 100 mm.

Capacity per shelf 90 kg.

3392 | 3393

with open side panel.

5392 | 5393 | 4392 | 4393

As 3392 | 3393, but with 2-leaf door of angle steel with welded wire lattice on open side.

Delivery includes 4 shelves.

Small-meshed wire mesh 40 x 40 x 4 mm

20% more wire than with the typical mesh width of 50 x 50 x 4 mm.

This results in significantly enhanced stability and higher access safety.



3392 | 3393



4392 | 4393 Padlock lockable rod system



5392 | 5393 Vertical locking rod



Vertical locking rod

With turning lever and cylinder lock.



Padlock lockable rod system

Easy to handle, replaceable locks. Locking rod does not project.

Delivery without padlocks.



TOTALSTOP - the fetra central brake system

With only one foot the rotation of the wheels and the swivelling movement of both swivel castors can be securely locked. The brake pedal is always visible to the operator.

All products on this double page are equipped as standard with TOTALSTOP.

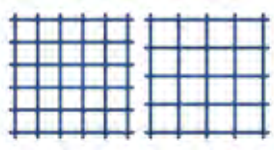

	Order no.	Capacity kg	Wheel-Ø mm	No. of shelves	Platform size L x W mm	Outside dimensions L x W x H mm	Net weight kg	Add. shelves	
								Order no.	
Box carts	3392	750	200	5	1000 x 680	1170 x 700 x 1792	133	1325	
	3393	750	200	5	1200 x 780	1370 x 800 x 1792	151	1926	
	4392	750	200	5	1000 x 680	1170 x 740 x 1792	154	1325	
	4393	750	200	5	1200 x 780	1370 x 840 x 1792	176	1926	
	5392	750	200	5	1000 x 680	1170 x 745 x 1792	144	1325	
	5393	750	200	5	1200 x 780	1370 x 845 x 1792	175	1926	



5492 | 5493 Galvanized steel sheet



5592 | 5593 Aluminium sheet



5792 | 5793

Box carts
5492 | 5493

in angle steel construction with tubular handlebar, powder coated. Ends, 1 side, folding door and roof covered.

Double wing door made of angle steel with vertical locking rod and integrated cylinder lock. 1 fixed and 4 detachable wood material shelves, surface beech grain.

2 swivel and 2 fixed-wheel castors with TPE tyres (thermo-plastic elastomer), hubs with groove ball bearing.

TOTALSTOP central braking system standard on swivel castors.

Maximum comfort: Very low starting, rolling and swivelling resistance. Low noise operation on level floors. Tyres are non-marking (trackless).

Delivery includes 4 shelves.

Shelf heights:
292, 582, 882, 1182, 1482 mm
Clearance between shelves
280 mm.

Variable use of shelves, in a grid of 100 mm.

Capacity per shelf 90 kg.

5492 | 5493

with galvanized 1 mm steel sheet.

5592 | 5593

As 5492 | 5493, but ends, side, folding door and roof covered with 1,5 mm aluminium sheet.

Delivery includes 4 shelves.

5792 | 5793

As 5492 | 5493, but doors covered with 4 mm break-resistant transparent plastic (polycarbonate).



TOTALSTOP - the fetra central brake system

With only one foot the rotation of the wheels and the swivelling movement of both swivel castors can be securely locked. The brake pedal is always visible to the operator.

All products on this double page are quipped as standard with TOTALSTOP.



	Order no.	Capacity kg	Wheel-Ø mm	No. of shelves	Platform size L x W mm	Outside dimensions L x W x H mm	Net weight kg	Add. shelves	
								Order no.	
Box carts	5492	750	200	5	1000 x 680	1170 x 745 x 1792	162	1325	
	5493	750	200	5	1200 x 780	1370 x 845 x 1792	199	1926	
	5592	750	200	5	1000 x 680	1170 x 745 x 1792	141	1325	
	5593	750	200	5	1200 x 780	1370 x 845 x 1792	173	1926	
	5792	750	200	5	1000 x 680	1170 x 745 x 1792	151	1325	
	5793	750	200	5	1200 x 780	1370 x 845 x 1792	177	1926	

STOREROOM TROLLEYS

Surface:

Smooth, corrosion-protected and visually appealing thanks to bright galvanised finish.

Variable:

Shelves can be inserted horizontal or inclined in a 100 mm grid. One longitudinal side with rim, the other flush.



Large variety of accessories:

Allows customisation for multiple requirements.

Smooth running castors:

4 swivel castors with TPE wheels, groove ball bearings and thread protection. High manoeuvrability, low rolling resistance, non-marking. Deflective TPU rings prevent bumping damage.

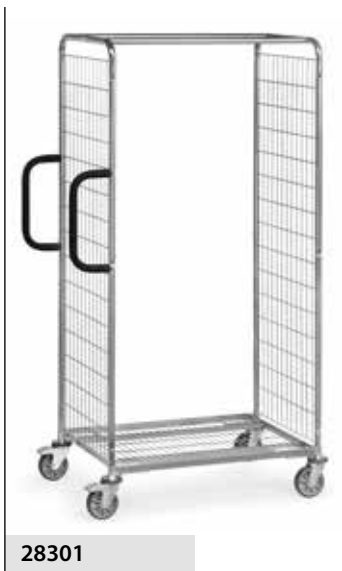

Storeroom trolleys Modular system

Sectional/tubular steel construction, completely electrolytically galvanised.

End panels made of tubular steel of wire lattice, mesh width 100 x 50 mm, reinforced by 2 longitudinal bracings.

Lower shelf fixed to base frame with wire lattice, mesh width 120 x 30 mm.

2 push bars on front side, vertically screwable.

4 smooth running swivel castors with TPE tyres with plastic rim, hubs with groove ball bearings and thread protection. 2 swivel castors with wheel locks.

4 protective rings made of TPU (thermoplastic polyurethane) on the swivel castors.

28100 | 28101 | 28102
Height 1225 mm

28200 | 28201 | 28202
Height 1625 mm

28301 | 28302
Height 1825 mm

Accessories for storeroom trolleys

- Clip board
- Identification board
- Bottle holder
- Scanner holder
- Shelves made of wire lattice
- Guide roller
- Shaft and tow hitch
- Steps
- Separating grid shelves made of wire lattice
- Separating grid for base frame shelf
- Screwable back wall
- Folding door and double folding door
- Handles for lateral shifting
- Tablet holder
- Notebook holder
- Document box

Accessories
on pages 84-87

	Order no.	Capacity kg	Wheel-Ø mm	Platform size L x W mm	Outside dimensions L x W x H mm	Loading height mm	Net weight kg
Storeroom trolleys	28100	200	125	650 x 510	891 x 590 x 1225	193	22
	28101	300	125	850 x 610	1091 x 690 x 1225	193	25
	28102	300	125	1250 x 610	1491 x 690 x 1225	193	28
	28200	200	125	650 x 510	891 x 590 x 1625	193	25
	28201	300	125	850 x 610	1091 x 690 x 1625	193	28
	28202	300	125	1250 x 610	1491 x 690 x 1625	193	31,5
	28301	300	125	850 x 610	1091 x 690 x 1825	193	30
	28302	300	125	1250 x 610	1491 x 690 x 1825	193	33



Shelf made of wire lattice

Shelf made of wire lattice with mesh width 120 x 30 mm, electrolytically galvanised.

On the long sides with 23 mm upward folded rim, on the other side 23 mm downward folded rim.

Variable use of shelves, in a grid of 100 mm horizontal or tilted insertable.

Capacity of shelf 40 resp. 80 kg.

Separating grid for shelves

As divider for shelves. With welded clamping lug.

Wire lattice, electrolytically galvanised.

Size: W x H 506/606 x 95 mm
Mesh width: 25 mm

Separating grid for base frame

As divider for base frame. With welded clamping lug.

Wire lattice, electrolytically galvanised.

Size: W x H 506/606 x 95 mm
Mesh width: 25 mm

Steps

3 steps, upper step 600 mm high, grip height approx. up to 2.800 mm.

Tubular steel frame, steps made of non-slip wood.

In loaded position steps stand firmly on the ground. Therefore the trolley is automatically blocked. At low load an engaging lock prevents the tilting of the trolley. The steps can be tilted assisted by a gas spring.

Also included in delivery of the steps are 2 more protruding and higher push bars to hold tight and lean. Total length of trolley increases by 100 mm.

Not combinable with shaft and tow hitch.

Utility model
20 2014 009 975.8

Guide roller

A fifth TPE tyre on a spring-loaded arm made of tubular steel. As guide roller for good directional stability.

Turning on the spot stays possible.

Accessories
on pages 85-87

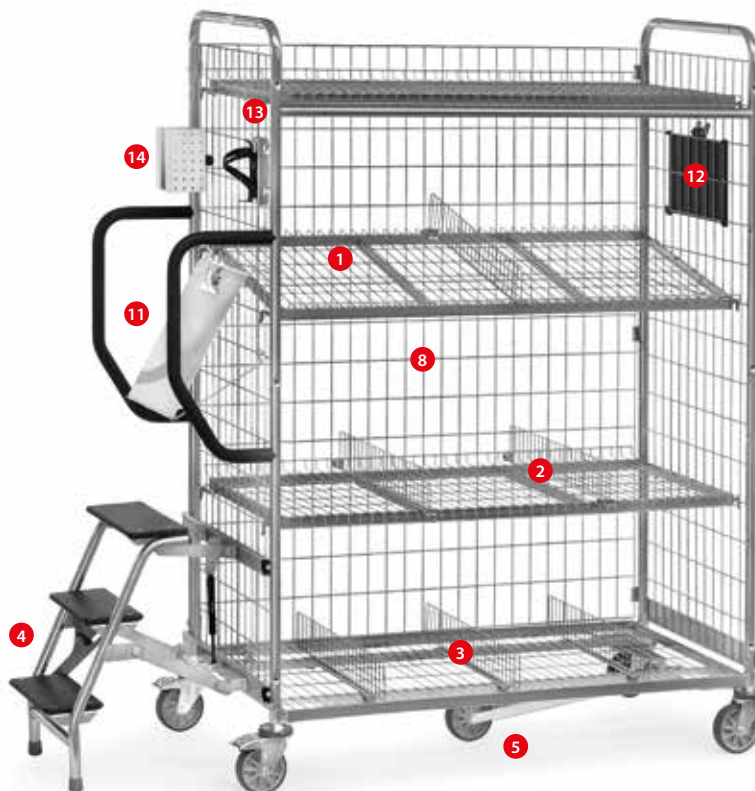

Shelf made of wire lattice



Separating grid for shelves



Separating grid for base frame



Steps tilted



Steps fold out



Shaft and tow hitch



Guide roller

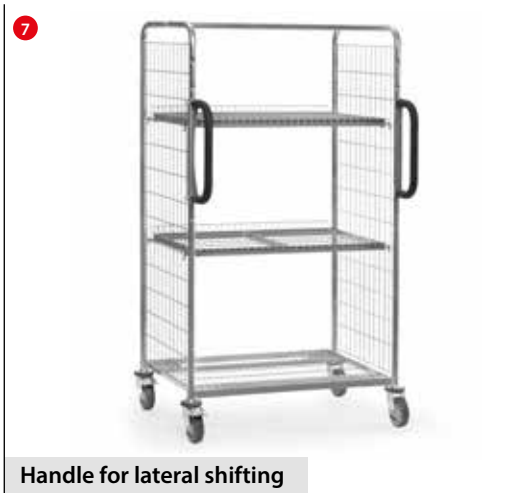

Handle for lateral shifting



Screwable back wall

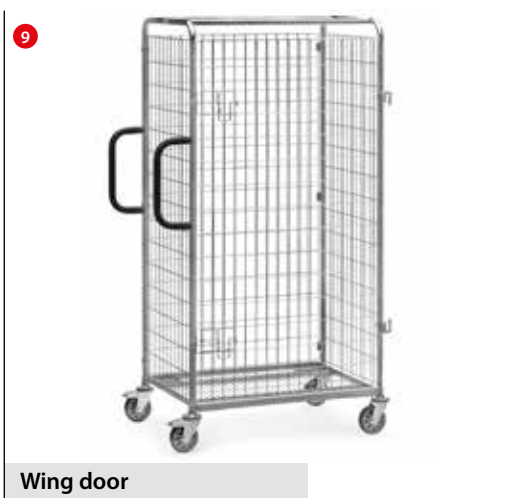

Wing door



Double wing door

Shaft and tow hitch

For moving with max. 3 storeroom trolleys in a train.
 2 swivel castors without wheel locks will be replaced by 2 fixed-wheel castors.
 Shaft made of sheet steel.
 Shaft raises automatically via gas spring into vertical resting position.
 Robust coupling pin on the fixed-wheel side. Connection via foot operation possible.
 Max. train speed 6 km/h.
 Not combinable with steps.

Handle for lateral shifting

Push bars with softgrip can be screwed vertical at the outside of the end panels. Therefore lateral shifting of the storeroom trolleys becomes easier.

Back wall

As long panel screwable.
 Made of wire lattice, electrolytically galvanized. Mesh width of end panel 100 x 50 mm.
 3 heights and 3 widths, suitable for the various trolley types and measures.

Wing door and double wing door

Wire frame galvanic bright galvanized, mesh width 100 x 50 mm. Hinges can be screwed on. Door wings can be folded by 180° to the car body. 2 wire iron closures lockable by means of padlock (not included).

FIXSTOP

Central directional locking.
 2 swivel castors with bolt hole and 2 swivel castors with plate fastening fixable in a grid of 4 x 90°.

Not combinable with guide roller.

Ideal in train combination with shaft and tow hitch.

Fig.	Description		For platform size L x W mm	Order no.	
1	Shelves made of wire lattice	40 kg capacity	650 x 510	28DG0	
		80 kg capacity	850 x 610	28DG1	
		80 kg capacity	1250 x 610	28DG2	
5	Guide roller Ø 125 mm		650 x 510	28SP0	
			850 x 610	28SP1	
			1250 x 610	28SP2	
7	Handle for lateral shifting			28SQ	

Fig.	Description	Platform width 510 mm		Platform width 610 mm	
		Order no.		Order no.	
2	Separating grid for shelves made of wire lattice	28TG5B		28TG6B	
3	Separating grid for base frame shelf	28TG5F		28TG6F	
4	Steps	28TS5		28TS6	
6	Shaft and tow hitch	28DK5		28DK6	

Fig.	Description	For platform size L x W mm	Height 1225 mm		Height 1625 mm		Height 1825 mm	
			Order no.		Order no.		Order no.	
8	Screwable back wall	650 x 510	28RW10		28RW20		–	
		850 x 610	28RW11		28RW21		28RW31	
		1250 x 610	28RW12		28RW22		28RW32	
9	Wing door	650 x 510	28FT10		28FT20		–	
		850 x 610	28FT11		28FT21		28FT31	
10	Double wing door	1250 x 610	28FT12		28FT22		28FT32	



Clip board

Can be clipped to the wire lattice of side panels, inclination adjustable via support brackets. With paper clamp. Steel sheet, powder coated grey RAL 7035. Effect. size: W x H 335 x 352 mm



Clip board



Example of use

Identification board

Steel sheet, matt black powder coated, suitable for writing with chalk. Can be clipped to wire lattice of side panels. With paper clamp. Effect. size: H x W 210 x 330 mm



Identification board



Example of use

Bottle holder

Made of plastic with steel mounting. Stable and flexible. Suitable for all commercially available beverage bottles and cans from 0,33 to 1,5 litres content.



Bottle holder



Example of use

Scanner holder

Steel sheet, powder coated RAL 7035. With adjustable bolt-on points at the back and sides. Tubular strut with multiple holes, with clamping bracket for attaching the scanner bag onto almost any position. Scanner intake W x D x H: 120 x 87 x 150 mm. Front opening: 40 mm wide

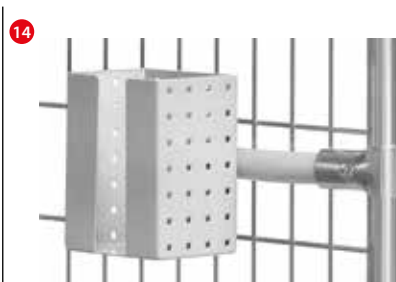

Scanner holder



Example of use



Fig.	Description	Order no.	
11	Clip board	28ST3	
12	Identification board	28KT3	
13	Bottle holder	28FH	
14	Scanner holder	1392	



Document box



Example of use

Document box

Steel sheet galvanised. Can be clipped to the wire lattice of side panels. Due to two insertable divider up to three compartments possible. Recessed pic up area. Window as occupancy display. Inside dimensions W x H x D: 320 x 170 mm (Depth of compartments during use of dividers 13 mm)



Notebook holder



Example of use

Notebook holder

Steel sheet galvanised. Can be clipped to the wire lattice of side panels. Ventilation slots at sides and bottom. Inside dimensions W x D x H: 460 x 322 x 16 mm



Tablet holder



Example of use

Tablet holder

Steel sheet galvanised. Can be clipped to the wire lattice of side panels. Inclination adjustable via support brackets. Tablets and Smartphones fixed by eccentric levers safe and gentle. Clamping bar padded with foam rubber, anti-slip covering strips for individual self mounting. Clamping area W x H x D: 200 x 15-295 x 14 mm



Fig.	Description	Order no.	
15	Document box	28DB	
16	Notebook holder	28NH	
17	Tablet holder	28TH	



Storeroom trolleys with steps

Welded tubular and sectional steel, powder coated. Shelves made of derived timber material boards in angle steel frame, 12 mm high skirting.

2 swivel and 2 fixed-wheel castors, TPE tyres. Hubs with groove ball bearing.

Swivel castors with wheel locks.

Capacity upper and middle shelves 80 kg.

At the face ends wooden steps lifting automatically when released and standing firmly on the floor when under load, whereby the trolley is automatically locked. You can hold onto or lean against the safety handle provided. The steps can be tilted easily assisted by a gas spring.

Utility model

20 2014 009 975.8

2105 | 2106

When steps are fold out the total length increases by 185 mm.

2107 | 2108

When steps are fold out the total length increases by 430 mm.

Accessories

Scanner holder 1392

Steel sheet, powder coated RAL 7035.

With adjustable bolt-on points at the back and sides. Tubular strut with multiple holes, with clamping bracket for attaching the scanner bag onto almost all of our products in virtually any position.

Scanner intake W x D x H:

120 x 87 x 150 mm

Front opening: 40 mm wide



2105



2106



2107



2108



Steps tilted



Bottle holder

For details see page 185.



Tablet holder

For details see page 87.



Scanner holder

Virtually any position.



Order no.	Capacity kg	Wheel-Ø mm	Platform size L x W mm	Outside dimensions L x W x H mm	No. of shelves	Height of step mm	Clearance betw. steps	Shelf heights mm	Net weight kg
2105	250	125	1000 x 600	1322 x 611 x 1155	2	504	252	200, 820	45
2106	250	125	1000 x 600	1322 x 611 x 1155	3	504	252	200, 510, 820	57
2107	250	125	1000 x 600	1322 x 611 x 1880	3	928	232	200, 825, 1445	64
2108	250	125	1000 x 600	1322 x 611 x 1880	4	928	232	200, 680, 1155, 1630	77
1392	-	-	-	-	-	-	-	-	1

EURO BOX CARTS

Robust:

400 kg capacity due to stable tubular and sectional steel construction and high-quality castors.

Selves:

Can be bolted in a 100 mm grid, either horizontal or inclined. Support struts for easier loading and unloading.

**4 TPE swivel castors:**

High-quality non-marking fetra TPE tyres with groove ball bearing. High manoeuvrability due to 4 swivel castors.

Euro box rollers

Suitable for Euro boxes 600 x 400 mm, powder coated, blue RAL 5007, 4 swivel castors with TPE tyres, hubs with groove ball bearing. 2 swivel castors with wheel locks.

13580 | 13680

Open angle steel construction.

13585

Steel plate tray leak-proof welded. Rim 22 mm high. Especially adapted for the transport of open-worked boxes with lubricated or wet parts. Nothing drips on the floor.

13581

With platform made of derived timber boards, rim 15 mm high.

13582

With platform made of derived timber material board, flush with frame.

13590

Box roller made of plastic (ABS 1st choice). Colour blue. 4 swivel castors, 2 swivel castors with wheel locks, wheels made of polyamide, hubs with glide bearing. Flat packed delivery.

Insertable shaft**13560**

insertable shaft for 13580 | 13581 | 13585 | 13680.

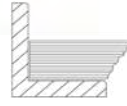
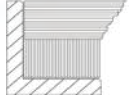
**13580 | 13680****13585****13581****13582****13590****13560**

	Order no.	Capacity kg	Wheel-Ø mm	Platform size L x W mm	Loading height mm	Type	Net weight kg
Euro box rollers	13580	250	125	605 x 405	182	open frame	9
	13680	250	125	810 x 610	182	open frame	11
	13585	250	125	605 x 405	182	steel plate platform	13
	13581	250	125	605 x 405	194	with boards	11
	13582	250	125	605 x 405	209	with boards	12
	13590	250	100	605 x 405	145	open frame	4
	13560	-	-	-	-	-	1,4

Euro boxes on page 100

Accessories
on pages 184-185



Euro box rollers

with push handle. Suitable for Euro boxes 600 x 400 mm, powder coated, blue RAL 5007, 4 swivel castors with TPE tyres, hubs with groove ball bearing. 2 swivel castors with wheel locks.

135800
Open angle steel construction.

135810
With platform made of derived timber boards, rim 15 mm high.

135820
With platform made of derived timber material board, flush with frame.

13587
Open angle steel construction with tubular push bar. The face end of the frame opposite the push bar is open (without rim), so that boxes can be drawn on or off.



	Order no.	Capacity kg	Wheel-Ø mm	Platform size L x W mm	Loading height mm	Type	Net weight kg
Euro box rollers	135800	250	125	605 x 405	182	open frame	11
	135810	250	125	605 x 405	182	with boards	13
	135820	250	125	605 x 405	209	with boards	14
	13587	250	125	605 x 405	182	open frame	11

Euro boxes on page 100

Accessories on pages 184-185



Euro box rollers

Compatible for Euro boxes
600 x 400 mm, powder coated
blue RAL 5007.

4 swivel castors with TPE tyres,
hubs with groove ball bearing.
2 wheels with locks.

Flat packed delivery.

13540

Roller with 2 platforms. Both
platforms of derived timber
material board housed in
frames, rim 15 mm high.
Clearance between platforms
400 mm, total height 638 mm.
Capacity of upper shelf 100 kg.

13550

As 13540, but platforms flush
with top edge of frame.
Capacity of upper shelf 100 kg.

135400

As 13540, but with tubular
push bar, total height 970 mm.
Capacity of upper shelf 100 kg.

135500

as 13550, but with tubular push
bar, total height 970 mm.
Capacity of upper shelf 100 kg.

135600

Roller with 2 shelf frames for
Euro boxes. Clearance between
shelf frames 500 mm, total
height 970 mm.
Capacity of upper shelf 80 kg.

135610

As 135600, but with shelves of
derived timber material board
housed in frames, rim 15 mm
high.
Capacity of upper shelf 80 kg.



13540

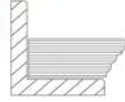

13550

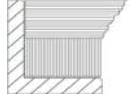

135400



135500



135600



135610

Euro boxes on page 100

**Accessories
on pages 184-185**

	Order no.	Capacity kg	Wheel-Ø mm	Platform size L x W mm	Loading heights mm	Type	Net weight kg
Euro box rollers	13540	250	125	605 x 408	194, 623	with boards	17
	13550	250	125	605 x 405	209, 638	with boards	19
	135400	250	125	605 x 408	194, 623	with boards	18
	135500	250	125	605 x 405	209, 638	with boards	21
	135600	250	125	605 x 405	182, 712	open frames	15
	135610	250	125	605 x 405	194, 724	with boards	19



2380



2390



2381



2391



2382



2392

Euro box carts Modular system

Tubular and sectional steel construction, bolted, powder coated.

4 swivel castors with TPE tyres, hubs with groove ball bearing, 2 wheels with locks.

Variable use of shelf frames, distance 50 mm, angle when inclined up to 15° and 30°.

Capacity per shelf 80 kg.

2380 | 2390

3 shelf-frames for 1 – 2 Euro boxes each 600 x 400 mm.

Delivery without boxes.

2381 | 2391

With 3 platforms made of derived timber material boards, rim 13 mm high.

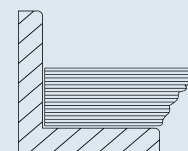

2382 | 2392

Open frames with 3 or 6 Euro boxes 600 x 400 x 145 mm.

	Order no.	Capacity kg	Wheel-Ø mm	Platform size L x W mm	Outside dimensions L x W x H mm	Type	Loading heights mm	Net weight kg
Euro box carts	2380	250	125	410 x 610	525 x 666 x 1101	open frames	238, 538, 838	27
	2390	250	125	820 x 610	935 x 666 x 1101	open frames	238, 538, 838	33
	2381	250	125	410 x 610	525 x 666 x 1101	with boards	251, 551, 851	35
	2391	250	125	820 x 610	935 x 666 x 1101	with boards	251, 551, 851	48
	2382	250	125	410 x 610	525 x 666 x 1101	with boxes	238, 538, 838	32
	2392	250	125	820 x 610	935 x 666 x 1101	with boxes	238, 538, 838	53

Euro boxes on page 100

Accessories
on pages 183-185

(No bigger wheel-Ø possible)



Euro box carts
Modular system

Euro box carts, tubular and sectional steel construction, bolted, powder coated blue RAL 5007.

4 swivel castors with TPE tyres, hubs with groove ball bearing, 2 wheels with locks.

Variable use of shelf frames, distance 100 mm, angle when inclined 15° and 30°.

Shelf heights:
300, 600, 900, 1200, 1500 mm
Capacity per shelf 80 kg.

1370
5 shelf-frames for every 2 euro boxes each 600 x 400 mm.

Delivery without boxes.

1371
With 5 platforms made of derived timber material boards, rim 13 mm high.

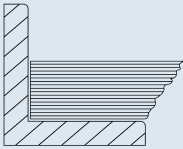

1372
with 10 euro boxes 1335, 600 x 400 x 145 mm.



1370



1371



1372

Euro boxes on page 100

Accessories
on pages 183-185

(No bigger wheel-Ø possible)

	Order no.	Capacity kg	Wheel-Ø mm	Platform size L x W mm	Outside dimensions L x W x H mm	Type	Loading heights mm	Net weight kg
Euro box carts	1370	400	160	820 x 610	935 x 666 x 1686	open frames	298, 598, 898, 1198, 1498	59
	1371	400	160	820 x 610	935 x 666 x 1686	with boards	311, 611, 911, 1211, 1511	84
	1372	400	160	820 x 610	935 x 666 x 1686	with boxes	298, 598, 898, 1198, 1498	68



1383



1384



1398



1399

**Euro box carts
Modular system**

Euro box carts, tubular and sectional steel construction, bolted, powder coated blue RAL 5007.

4 swivel castors with TPE tyres, hubs with groove ball bearing, 2 wheels with locks.

Variable use of shelf frames, distance 100 mm, angle when inclined 15° and 30°.

Shelf heights: 300, 600, 900, 1200, 1500 mm

Capacity per shelf 80 kg.

1383

5 shelf-frames for 3 euro boxes each 600 x 400 mm. Delivery without boxes.

1384

With 5 platforms made of derived timber material boards, rim 13 mm high.

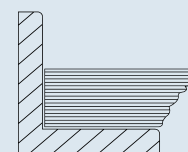

1398

With euro boxes
3 boxes 600 x 400 x 145 mm
6 boxes 600 x 400 x 170 mm
6 boxes 600 x 400 x 220 mm.

1399

With 15 euro boxes 1335, 600 x 400 x 145 mm.

	Order no.	Capacity kg	Wheel-Ø mm	Platform size L x W mm	Outside dimensions L x W x H mm	Type	Loading heights mm	Net weight kg
Euro box carts	1383	400	160	1240 x 610	1372 x 685 x 1686	open frames	298, 598, 898, 1198, 1498	70
	1384	400	160	1240 x 610	1372 x 685 x 1686	with boards	311, 611, 911, 1211, 1511	109
	1398	400	160	1240 x 610	1372 x 685 x 1686	with boxes	298, 598, 898, 1198, 1498	97
	1399	400	160	1240 x 610	1372 x 685 x 1686	with boxes	298, 598, 898, 1198, 1498	96

Euro boxes on page 100

Accessories
on pages 183-185
(No bigger wheel-Ø possible)



Storage trolleys
Modular system

Tubular steel and steel section construction, powder coated.

2 swivel and 2 fixed-wheel castors, TPE tyres, 125 x 32 mm, hubs with groove ball bearing.

Swivel castors with wheel locks.

Capacity upper and middle shelf 50 kg.

32900 | 32910

Open frames without board.

Loading heights:
197, 652, 1152 mm

32901 | 32911

With 3 platforms made of derived timber material boards, rim 13 mm high.

Loading heights:
209, 664, 1164 mm

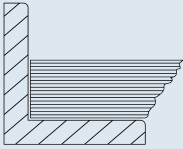

32902 | 32912

With 3 plastic boxes,
1 pc. 600 x 400 x 145 mm
2 pcs. 600 x 400 x 220 mm.

Loading heights:
197, 652, 1152 mm

32910 | 32911 | 32912

Storage trolley with tiltable surfaces. Upper and middle platform tiltable to both sides by 15° and 30°, locked by spring catch.



32900



32910



32901



32911



32902



32912

	Order no.	Capacity kg	Wheel-Ø mm	Platform size L x W mm	Outside dimensions L x W x H mm	Type	Net weight kg
Storage trolleys	32900	200	125	605 x 405	821 x 455 x 1178	open frames	22
	32910	200	125	605 x 405	821 x 455 x 1178	open frames	24
	32901	200	125	605 x 405	821 x 455 x 1178	with boards	31
	32911	200	125	605 x 405	821 x 455 x 1178	with boards	33
	32902	200	125	605 x 405	821 x 455 x 1282	with boxes	28
	32912	200	125	605 x 405	821 x 455 x 1282	with boxes	30

Euro boxes on page 100

Accessories
on pages 183-185



32920



32921



32930



32931

**Storage trolleys
Modular system**

Made of tubular and sectional steel, welded and powder coated blue RAL 5007, bolted construction.

2 swivel and 2 fixed-wheel castors, TPE tyres, 125 x 32 mm, hubs with groove ball bearing.

2 wheels with locks.

Loading heights:
285, 540, 795, 1050 mm

Capacity per shelf 60 kg.

32920

4 shelves of derived timber board, rim 10 mm high.

32921

Design as 32920, but additionally with 4 storage boxes 1786, dimensions L x W x H: 500/450 x 310 x 200 mm.

32930

4 shelves of derived timber board, rim 10 mm high.

32931

Design as 32930, but additionally with 8 storage boxes 1786, dimensions L x W x H: 500/450 x 310 x 200 mm.

	Order no.	Capacity kg	Wheel-Ø mm	Platform size L x W mm	Outside dimensions L x W x H mm	Type	Net weight kg
Storage trolleys	32920	250	125	320 x 470	430 x 513 x 1130	with boards	24
	32921	250	125	320 x 470	430 x 513 x 1250	with boxes	29
	32930	250	125	630 x 470	740 x 513 x 1130	with boards	32
	32931	250	125	630 x 470	740 x 513 x 1250	with boxes	43

**Storage boxes
on page 100**



Storage trolleys Modular system

Made of tubular and sectional steel, welded and powder coated blue RAL 5007, bolted construction.

2 swivel and 2 fixed-wheel castors, TPE tyres, 125 x 32 mm, hubs with groove ball bearing.

2 wheels with locks.

Loading heights:

285, 540, 795, 1050 mm

Capacity per shelf 60 kg.

32940

4 shelves of derived timber boards, rim 10 mm high.

32941

Design as 32940, but additionally with 12 storage boxes 1786, dimensions L x W x H: 500/450 x 310 x 200 mm.

32950

4 shelves of derived timber board, rim 10 mm high.

32951

Design as 32950, but additionally with 16 storage boxes 1786, dimensions L x W x H: 500/450 x 312 x 200 mm.



32940



32941



32950



32951

Storage boxes
on page 100

	Order no.	Capacity kg	Wheel-Ø mm	Platform size L x W mm	Outside dimensions L x W x H mm	Type	Net weight kg
Storage trolleys	32940	250	125	940 x 470	1050 x 513 x 1130	with boards	42
	32941	250	125	940 x 470	1050 x 513 x 1250	with boxes	58
	32950	250	125	1250 x 470	1360 x 513 x 1130	with boards	50
	32951	250	125	1250 x 470	1360 x 513 x 1250	with boxes	71



2881



2882



2883



2884



2891



2892

Assembly trolleys Modular system

Made of tubular and sectional steel, welded and powder coated blue RAL 5007, bolted construction.

4 swivel castors with TPE tyres 125 x 32 mm, hubs with groove ball bearing.

Variable use of shelves, steel frame with inserted derived timber material board, surface beech grain, 12 mm high skirting. Distance 100 mm, angle continuously adjustable of 0° to 35°. Secure locking by handle screws.

Capacity per shelf 60 kg.

German Patent
10 2005 062 391

2881 | 2883

One-sided construction, 3 shelves made of derived material timber board, 12 mm high skirting.

2882

Construction as 2881, but additionally with 12 storage boxes; dimensions L x W x H 230/200 x 147 x 132 mm and 4 boxes 350/300 x 210 x 145 mm.

2884

Construction as 2883, but additionally with 12 Euro boxes size L x W x H 400 x 300 x 145 mm.

2891

Two-sided construction, two-part shelves made of derived material timber board, 12 mm high skirting.

2892

Construction as 2891, but additionally with 16 storage boxes; dimensions L x W x H 230/200 x 147 x 132 mm and 24 boxes 350/300 x 210 x 145 mm and 12 boxes 350/300 x 210 x 200 mm.

Additional shelves

Add. shelf for	Order no.
2881 2882	2888
2883 2884	2899
2891 2892	2898

Order no.	Capacity kg	Platform size L x W mm	Outside dimensions L x W x H mm	Type	No. of shelves	Loading heights mm	Net weight kg
2881	250	900 x 315	1050 x 362 x 1205	with boards	3	370, 670, 970	33
2882	250	900 x 315	1050 x 362 x 1205	with boxes	3	370, 670, 970	40
2883	250	1240 x 415	1355 x 477 x 1197	with boards	3	370, 670, 970	46
2884	250	1240 x 415	1355 x 477 x 1197	with boxes	3	370, 670, 970	56
2891	300	1280 x 2 x 315	1420 x 740 x 1530	with boards	4	370, 670, 970, 1270	96
2892	300	1280 x 2 x 315	1420 x 740 x 1530	with boxes	4	370, 670, 970, 1270	123

Euro and Storage boxes
on page 100

Storage boxes**1781 - 1786**

Made of robust impact-resistant synthetic material, smooth surface and therefore easy to clean. Colour grey.

Euro boxes**1308 - 1339**

In standard Euro dimensions, made of high-quality, shock-resistant plastic, mainly Polyethylene (PE) and Polypropylene (PP). These materials are resistant to all common alkaline solutions and acids, neutral to smell and taste, physiologically recognized as safe and remain in the temperature range between -40° and $+100^{\circ}$ stable as far as dimensions and material is concerned. Colour grey.

Cover for euro boxes**1315 | 1338**

Hinge lid with 2 spring locks, lid can be security-sealed.



	Order no.	Outside dimensions L x W x H mm	Inside dimensions L x W x H mm	Content litres	Capacity kg	Net weight kg
Storage boxes	1781	170/145 x 102 x 78	–	–	1	0,1
	1782	230/200 x 147 x 132	–	–	3,2	0,3
	1783	350/300 x 210 x 145	–	–	8	0,6
	1784	350/300 x 210 x 200	–	–	10,5	0,8
	1786	500/450 x 310 x 200	–	–	24,5	1,4
Euro boxes	1309	400 x 300 x 145	366 x 264 x 130	12	15	0,9
	1335	600 x 400 x 145	558 x 358 x 142	28	20	1,6
	1330	600 x 400 x 170	558 x 358 x 165	33	20	3,3
	1336	600 x 400 x 220	558 x 358 x 216	43	20	1,8
	1339	600 x 400 x 280	558 x 358 x 275	55	20	2,3
	1308	600 x 400 x 325	558 x 358 x 320	64	20	3,8
	1337	600 x 400 x 425	570 x 370 x 422	89	20	3,6
Cover	1315	400 x 300	–	–	–	0,4
	1338	600 x 400	–	–	–	0,7

MOBILE TILTING STANDS

High quality:

Robust steel structure and resilient powder coating. Made in Germany



4 high-quality castors:

For easy movement and optimal manoeuvrability. 2 of them with locks.

Individual:

Various platform and adjusting systems.



Adjustable in height

Ergonomic:

Less stress on the spine while work standing or sitting. Adjustable in height.

Mobile tilting stands

For plastic boxes, steel plate boxes, wire baskets etc., adjustable in height and mobile.

Sectional steel-/ tubular construction with steel plate platform. Powder coated blue RAL 5007. 4 swivel castors with TPE tyres, hubs with bush bearing, 2 wheels with locks.

3260 | 3270

Steel plate platform with all side rim, 20 mm high. Not inclinable, adjustable in height in intervals of 25 mm.



3260



3270

3280 | 3282

Steel plate platform with single-sided lay-on edge, straight or inclinable by 15° und 30°, adjustable in height in intervals of 25 mm.



3280



3282



Example of use

	Order no.	Capacity kg	Wheel-Ø mm	Platform size L x W mm	Height adjustable from - to mm	Net weight kg	
Mobile tilting stands	3260	150	75	605 x 405	524-774	17	
	3270	150	75	605 x 405	720 - 995	17	
	3280	150	75	510 x 410	500 - 775	18	
	3282	150	75	510 x 410	755 - 1105	18	



3285



3286



3290



3291



3191

Mobile tilting stands

For plastic boxes, steel boxes, wire baskets etc., adjustable in height and mobile.

Sectional steel-/ tubular construction with steel plate platform. Powder coated blue RAL 5007. 4 swivel castors with TPE tyres, hubs with bush bearing, 2 wheels with locks.

3285

Steel plate platform with single-sided lay-on edge, straight or inclinable by 15° und 30°, continuously adjustable in height via rack and pinion jack, even under load. 2 telescopic pillars.

3286

Steel plate platform with single-sided lay-on edge, straight or inclinable by 15° und 30°, continuously adjustable in height via hydraulic pump, even under load. Operated via pedal, precisely adjustable via lowering valve.

3290 | 3291

Steel plate platform with single-sided lay-on edge, straight or inclinable by 15° und 30°, continuously adjustable in height, rotatable and lockable, with pneumatic lowering damping.

Roller support

3191

To support long materials on saws, presses, drills etc. Continuously adjustable in height, rotatable and lockable, with pneumatic lowering damping. Mobile. Supporting roller of tubular steel 450 mm, 60 mm Ø, ball bearing mounted. Loose gravity-stops on both sides 20 mm above top edge of roller (automatically turn away for wide work pieces).

4 swivel castors with locks. Flat packed for easy self assembly.

	Order no.	Capacity kg	Wheel-Ø mm	Platform size L x W mm	Height adjustable from - to mm	Net weight kg
Mobile tilting stands	3285	250	125	750 x 450	655 - 1025	35
	3286	250	125	750 x 450	720 - 1080	39
	3290	150	75	510 x 410	510 - 700	24
	3291	150	75	510 x 410	720 - 1070	28
Roller support	3191	150	75	-	780 - 1130	21

Disassembled delivery, easy self-assembly. Warranty for 3286, 3290/3291 and 3191 2 years.

HEAVY-DUTY CARTS



Modular system:

Multi-functional modular system with the proven fetra „Insert & Bolt Principle“. The Super MultiVario transport carts can be changed, swapped and added-on in many ways.

Platform:

Anti-skid waterproof plywood board.



Elastic solid rubber tyres:

Very comfortable due to easy, highly elastic running. Non-marking, hubs with ball bearings.

Sturdy and elegant:

Specially designed for heavy loads. Optical of one cast with round edges.

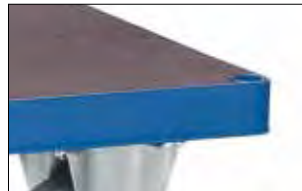



12592 | 12593 | 12595 | 12596



12582 | 12583 | 12585 | 12586



12502 | 12503 | 12505 | 12506

Super-MultiVario-Transporter Modular System

The Super-MultiVario-transporter is especially designed for heavy loads. High-quality elasticated solid-rubber wheels and hubs with ball bearings guarantee an extreme manoeuvrability and a smooth run. Steel tube and sectional steel welded, powder coated, blue RAL 5007. Platforms and ends made of antislip waterproof plywood boards (insert type of board).

2 swivel and 2 fixed-wheel castors, elasticated solid rubber tyres 200 x 50 mm, blue-grey „trackless“, hubs with ball bearings.

Swivel castors with wheel locks. Usable height 283 mm.

Stanchioned trolleys 12582 - 12586

With 4 insertable stanchions. Usable height 600 mm.

	Order no.	Capacity kg	Wheel-Ø mm	Platform size L x W mm	Outside dimensions L x W x H mm	Net weight kg
Platform trolleys	12592	1200	200	1000 x 700	1076 x 700 x 283	38
	12593	1200	200	1200 x 800	1276 x 800 x 283	42
	12595	1200	200	1600 x 800	1676 x 800 x 283	56
	12596	1200	200	2000 x 800	2076 x 800 x 283	86
Stanchioned trolleys	12582	1200	200	1000 x 700	1076 x 700 x 887	42
	12583	1200	200	1200 x 800	1276 x 800 x 887	46
	12585	1200	200	1600 x 800	1676 x 800 x 887	60
	12586	1200	200	2000 x 800	2076 x 800 x 887	90
Open carts	12502	1200	200	1000 x 700	1155 x 700 x 1005	42
	12503	1200	200	1200 x 800	1355 x 800 x 1005	47
	12505	1200	200	1600 x 800	1755 x 800 x 1005	60
	12506	1200	200	2000 x 800	2155 x 800 x 1005	87

Accessories
on pages 183-185



Super-MultiVario-Transporter Modular System

The Super-MultiVario-transporter is especially designed for heavy loads.

High-quality elasticated solid-rubber wheels and hubs with ball bearings guarantee an extreme manoeuvrability and a smooth run.

Steel tube and sectional steel welded, powder coated, blue RAL 5007. Platforms and ends made of antislip waterproof plywood boards (insert type of board).

2 swivel and 2 fixed-wheel castors, elasticated solid rubber tyres 200 x 50, blue-grey „track-less“ hubs with ball bearings. Swivel castors with wheel locks.



12512 | 12513 | 12515 | 12516



12497

Panelled end platform carts 12512 - 12516

Side panels made of antislip waterproof. Side panel height: 500 mm



12402 | 12403 | 12405 | 12406



12422 | 12423 | 12425 | 12426

Table top cart 12497

Square platforms. Capacity upper platform 500 kg.

Table top cart 12402 - 12406 12422 - 12426

Rectangular platforms. Capacity upper and middle platform 500 kg.



Add-on kit for table top carts
steel plate drawer with ball pull-out and cylinder lock.
Height x Width x Depth inside 105 x 410 x 475 mm.



Drawer subdivision-set
made of galvanized steel sheet, insertable. 2 longitudinal partitions and 6 dividing sheets.

Add-on kit 2149

Steel plate drawer with ball pull-out and cylinder lock.
Height x Width x Depth inside 105 x 410 x 475 mm
(2 kits per cart possible, for type 12497 1 kit per cart).

Accessories on pages 183-185

	Order no.	Capacity kg	Wheel-Ø mm	Platform size L x W mm	Outside dimensions L x W x H mm	Shelf heights mm	Net weight kg
Panelled end platform carts	12512	1200	200	1000 x 700	1155 x 700 x 1005	283	45
	12513	1200	200	1200 x 800	1355 x 800 x 1005	283	52
	12515	1200	200	1600 x 800	1755 x 800 x 1005	283	64
	12516	1200	200	2000 x 800	2155 x 800 x 1005	283	96
Table top carts	12497	1200	200	700 x 700	910 x 700 x 925	283, 925	54
	12402	1200	200	1000 x 700	1210 x 700 x 925	283, 925	67
	12403	1200	200	1200 x 800	1410 x 800 x 925	283, 925	77
	12405	1200	200	1600 x 800	1810 x 800 x 925	283, 925	100
	12406	1200	200	2000 x 800	2210 x 800 x 925	283, 925	156
	12422	1200	200	1000 x 700	1210 x 700 x 925	283, 604, 925	97
	12423	1200	200	1200 x 800	1410 x 800 x 925	283, 604, 925	108
	12425	1200	200	1600 x 800	1810 x 800 x 925	283, 604, 925	144
12426	1200	200	2000 x 800	2210 x 800 x 925	283, 604, 925	228	
Sheet steel drawer	2149	-	-	-	-	-	-
Subdivision-set	2148/ES	-	-	-	-	-	-

Super-MultiVario-Transporter Modular System

The Super-MultiVario-transporter is especially designed for heavy loads. Steel tube and sectional steel welded, powder coated, blue RAL 5007.

1 fix and 3 shelves made of waterproof stable plywood boards. 1 side anti-slip the other side smooth.

Variable use of shelves, minimum distance 100 mm.

Shelf heights: 283, 688, 1088, 1488 mm

Capacity per shelf 180 kg.

High-quality elasticated solid-rubber wheels and hubs with ball bearings guarantee an extreme manoeuvrability and a smooth run.

2 swivel and 2 fixed-wheel castors, elasticated solid rubber tyres 200 x 50, blue-grey „trackless“ hubs with ball bearings.

Swivel castors with wheel locks.

Shelved trolleys

18212 -1 | 18213-1

18312 -1 | 18313-1

Ends of tubular construction with intermediate uprights at intervals of approx. 130 mm. Detachable side panels, also with intermediate uprights.

Shelves

Additional charge or price reduction for shelves including 1 pair of support brackets.

Size mm	Order no.
1000 x 700	E18202ETAW
1200 x 800	E18203ETAW

Accessories on pages 183-185



18202 | 18203



18212-1 | 18213-1



18302 | 18303



18312-1 | 18313-1

	Ordern no.	Capacity kg	Wheel-Ø mm	Platform size LxW mm	Outside dimensions LxWxH mm	Net weight kg
Shelved trolleys	18202	1200	200	1000 x 700	1173 x 700 x 1583	85
	18203	1200	200	1200 x 800	1373 x 800 x 1583	101
	18212-1	1200	200	1000 x 700	1184 x 724 x 1583	103
	18213-1	1200	200	1200 x 800	1384 x 824 x 1583	121
	18302	1200	200	1000 x 700	1173 x 700 x 1817	84
	18303	1200	200	1200 x 800	1373 x 800 x 1817	103
	18312-1	1200	200	1000 x 700	1184 x 724 x 1817	110
	18313-1	1200	200	1200 x 800	1384 x 824 x 1817	128

TROLLEYS WITH CARRIER SPARS

Robust construction:

Strong frame made of square tube bolted together with sturdy brackets.

Variable system:

Carrier spars adjustable, either on one or both sides. Can be customised as needed with additional components.



TPE castor:

The innovative easy-running TPE-castor in the attractive fetra design is non-marking and odourless. Particularly smooth-running groove ball bearing.



Wooden shelves:

Made of water-resistant plywood with anti-skid and smooth side.



4614 | 4615 | 4616



4624 | 4625 | 4626

Trolleys with carrier spars

Modular system

A very versatile system for transport and storage of long goods. Carrier spars steplessly adjustable. Trolley completely bolted.

Frame made of sturdy square tube. Cross beams, posts and bars connected with solid screwed joints. Carrier spars made of tubular steel Ø 27 mm with screwed joints. Powder coated blue RAL 5007.

2 swivel and 2 fixed-wheel castors, TPE tyres, hubs with groove ball bearing. Swivel castors with wheel locks.

Flat packed delivery.

4614 | 4615 | 4616

12 one-side carrier spars, useful length 600 mm, useful height of stand 1450 mm.

Carrying capacity per level 80 kg.

4624 | 4625 | 4626

24 carrier spars on both sides (12 per side), useful length 370 mm, useful height of stand 1450 mm.

Carrying capacity per level 120 kg (60 kg per side).

Special version: PVC hose

Carrier spars covered with PVC hose, 3 mm thick, as anti-skid protection. Facilitates the careful handling of the goods.

Anti-skidding device

Insertable as a stopper at the end of the carrier spar.

Useful height: 30 mm

Useful height of PVC hose: 27 mm

Additional charge per trolley with

- one-side carrier spars
- carrier spars on both sides

Additional charge anti-skidding device for single carrier spar

Add „AS“ to order no. of the trolleys or carrier spar, e.g. „4614AS“ or „E4614TAAS“.

Push handle

can be bolted onto the outer post of the trolley by means of clamping brackets.

Order no. 4680

Accessories

on pages 110, 183-185



Trolley with carrier spars with PVC hose



Anti-skidding device

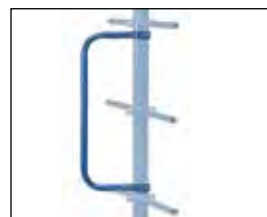

Push handle

	Capacity kg	Frame L x W mm	TPE tyres mm	Outside dimensions L x W x H mm	Trolley with carrier spars powder coated		Trolley with carrier spars powder coated with PVC hose	
					Order no.		Order no.	
Trolleys with carrier spars	500	1200 x 800	200 x 40	1400 x 800 x 1807	4614		4614-1	
	500	1600 x 800	200 x 40	1800 x 800 x 1807	4615		4615-1	
	500	2000 x 800	200 x 40	2200 x 800 x 1807	4616		4616-1	
	500	1200 x 800	200 x 40	1400 x 800 x 1807	4624		4624-1	
	500	1600 x 800	200 x 40	1800 x 800 x 1807	4625		4625-1	
	500	2000 x 800	200 x 40	2200 x 800 x 1807	4626		4626-1	

Modules for trolleys with carrier spars

Trolleys can be completed with these modules as often as required, e. g. with further posts and carrier spars or cross beams.

Shelves for trolleys with carrier spars

Platform of waterproof plywood 15 mm thick, usable on both sides, one side is smooth, the other side an anti-slip surface (plywood), with fastening clamps.

Carrier spars for trolleys with carrier spars 600 mm long

Not suitable for double-sided mounting.



Modules for trolleys with carrier spars



Shelves for trolleys with carrier spars



		Order no.	
Modules for trolleys with carrier spars	1	Horizontal bar 1200 mm long	E4614HS
		Horizontal bar 1600 mm long	E4615HS
		Horizontal bar 2000 mm long	E4616HS
	2	External post	E4614AP
	3	Middle post	E4614MP
	4	Cross beam (without rolls)	E4614RT
	5	Carrier spar 370 mm long (1 set = 2 pieces)	E4624TA
		Carrier spar 370 mm long with PVC-hose (1 set = 2 pieces)	E4624-1TA
	6	Carrier spar 600 mm long	E4614TA
		Carrier spar 600 mm long with PVC-hose	E4614-1TA

		For carrier spars without PVC hose		For carrier spars with PVC hose	
Size		Order no.		Order no.	
Shelves for trolleys with carrier spars	7	1200 x 600 mm	E4614ET		E4614-1ET
		1600 x 600 mm	E4615ET		E4615-1ET
		2000 x 600 mm	E4616ET		E4616-1ET
	8	1200 x 370 mm	E4624ET		E4624-1ET
		1600 x 370 mm	E4625ET		E4625-1ET
		2000 x 370 mm	E4626ET		E4626-1ET

WORK PIECE TROLLEYS

Tidiness at the assembling place:
Individual configuration with carriers, boxes and trays.

Extrem robust:
Stable angle steel construction, with wire lattice inwelded, mesh width 75 x 75 mm, wire thickness 7 mm!



TPE castor:
The innovative easy-running TPE-castor in the attractive fetra design is non-marking and odourless. Particularly smooth-running groove ball bearing..



Continuous loading platform:
Also in the centre for transporting long goods.



1301

Workpiece trolley, in sectional steel, with welded wire lattice 75 x 75 mm, powder coated, blue RAL 5007. Continuous platform of derived timber material board, surface beech grain.

2 swivel and 2 fixed-wheel castors, TPE tyres, hubs with precision deep groove ball bearing. Swivel castors with wheel locks, according to the European Standard EN 1757-3 (safety of platform trolleys).

Height of superstructure 1250 mm
 Total height 1536 mm
 Wire lattice frame inclined at 11%.



1301 with accessories

Accessories:

Steel welded, powder coated, grey RAL 7035

Thorn bracket

10 mm Ø, Length 200 and 300 mm, Capacity 10 kg



Thorn bracket 1310

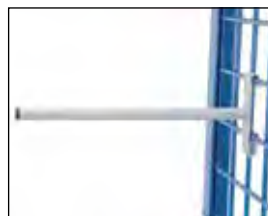

Tubular bracket 1312



Material box 1306

Tubular bracket

16 mm Ø, Length 300 mm, Capacity 15 kg
 22 mm Ø, Length 300 mm, Capacity 15 kg
 27 mm Ø, Length 300 mm, Capacity 25 kg



Tubular bracket 1302



Tubular bracket 1303



Material tub 1316

Corrugated bracket

Corrugation spacing, 55 mm, Length 320 mm, Capacity 25 kg



Corrugated bracket 1314



Forket bracket 1305



Storage box 1307

Forked bracket

Clearance 50 mm, Length 300 mm, Capacity 25 kg

Material box

L x W x H, 250 x 150 x 80 mm
 Capacity 25 kg

Material tub

L x W x H = 1200 x 250 x 40 mm
 Capacity 50 kg

Storage box, open

Polypropylene blue, L x W x H 300 x 230 x 150 mm

	Order no.	Capacity kg	Platform size L x W mm	TPE tyres mm	Net weight kg
Workpiece trolleys	1301	600	1200 x 800	200 x 40	90

	Order no.	Capacity kg	Size mm	Net weight kg
Thorn bracket	1310	10	10 Ø x 200 length	0,3
	1311	10	10 Ø x 300 length	0,4
Tubular bracket	1312	15	16 Ø x 300 length	0,3
	1302	25	22 Ø x 300 length	0,4
	1303	25	27 Ø x 300 length	0,5
Corrugated bracket	1314	25	320 length	0,6
Forket bracket	1305	25	50 mm clearance x 300 mm length	1,0
Material box	1306	25	L x W x H = 250 x 150 x 80	1,1
Material tub	1316	50	L x W x H = 1200 x 250 x 40	7,0
Storage box, open	1307		L x W x H = 300 x 230 x 150	0,5

Accessories

on pages 183-185

SHEET MATERIAL TRANSPORT

Perfect fit:

7 adjustment positions for insertable tubular supports, perfectly integrated into the frame design.

Various possibilities for applications:

For transporting and storing large panels.



TPE castor:

The innovative easy-running TPE-castor in the attractive fetra design is non-marking and odourless. Particularly smooth-running groove ball bearing.



Robust:

Standard capacity 750 kg, optional 1200 kg.



Dollies for sheet material 4155 | 4156

Dolly for sheet material with clamping jaws. Steel-welded construction, powder coated blue RAL 5007.

Jaw surface with felt coating. Wheels with either solid rubber or pneumatic tyres, hubs with roller bearings.

Secure clamping by the weight of the load on the clamping construction. Maximal clamping width: 0-60 mm



4155 | 4156



4157 | 4158

4157 | 4158

As 4155 | 4156, but clamping width 30-95 mm (suitable for windows).

Dollies for sheet material 4165 | 4166

Dolly for sheet material in U-form. Steel sheet construction, powder coated blue RAL 5007, interior surface with felt coating.

Wheels with either solid rubber or pneumatic tyres, hubs with roller bearings.

Clear width: 150 mm



4165 | 4166



4175 | 4176

4175 | 4176

Dolly for sheet material as 4165 | 4166, but with support and push bar.

Clear width: 150 mm



Example of use

	Order no.	Capacity kg	Height mm	Lifting blade length mm	Lifting blade width mm	Total width mm	Solid rubber tyres mm	Pneumatic tyres mm	Net weight kg
Dollies for sheet material	4155	250	305	300	60	284	260 x 56	–	8
	4156	250	305	300	60	298	–	260 x 85	6
	4157	250	307	300	95	319	260 x 56	–	8
	4158	250	307	300	95	333	–	260 x 85	6
	4165	500	260	500	150	343	260 x 56	–	8
	4166	400	260	500	150	357	–	260 x 85	6
	4175	500	905	500	150	343	260 x 56	–	10
	4176	400	905	500	150	357	–	260 x 85	8



**Carts for sheet material
1075 | 1076**

Carts for longitudinal transport of bulky wooden boards and plastic sheets. Tubular steel construction with steel sheet blade, powder coated blue RAL 5007.

Wheels with either solid rubber or pneumatic tyres. Hubs with roller bearings.

2 support wheels 50 mm Ø.

Flat packed delivery.

2075 | 2076

Cart for sheet material as 1075 | 1076 but fitted with rubber strip (nonskid).

With holding-down clamp as tilt lock.



Example of use

	Order no.	Capacity kg	Height mm	Lifting blade length mm	Lifting blade width mm	Total width mm	Solid rubber tyres mm	Pneumatic tyres mm	Net weight kg
Carts for sheet material	1075	400	1430	500	200	680	250 x 60	-	18
	1076	350	1440	500	200	680	-	260 x 85	16
	2075	400	1450	500	200	680	250 x 60	-	20
	2076	350	1460	500	200	680	-	260 x 85	18



Trolleys for sheet material

4411 | 4412 | 4413

With fixed tubular supports. Tubular steel and profile steel welded, powder coated blue RAL 5007. Platform made of derived timber material board, surface beech grain. Bolted tubular steel superstructure. 2 swivel and 2 fixed-wheel castors, TPE tyres, hubs with groove ball bearing. Swivel castors with wheel locks.

Effective height: 1050 mm

Height retaining bracket: 300 mm

4431 | 4432 | 4433

as 4411 | 4412 | 4413, but platform with glued-on fine rubber. Slip-resistant. Saves sensitive transport goods.

4445

Welded profile steel and steel tube. Anti-skid loading platform of waterproof plywood.

2 swivel and 2 fixed-wheel castors, TPE tyres, hubs with groove ball bearing. Swivel castors with wheel locks.

Effective height: 1150 mm



4411 | 4412 | 4413



4431 | 4432 | 4433



4445

	Order no.	Capacity kg	Wheel-Ø mm	Platform size L x W mm	Outside dimensions L x W x H mm	Net weight kg	
Trolleys for sheet material	4411	600	200	1070 x 335	1070 x 610 x 1321	36	
	4412	600	200	1070 x 435	1070 x 710 x 1321	41	
	4413	600	200	1270 x 535	1270 x 810 x 1321	45	
Trolleys for sheet material	4431	600	200	1070 x 335	1070 x 610 x 1321	34	
	4432	600	200	1070 x 435	1070 x 710 x 1321	39	
	4433	600	200	1270 x 535	1270 x 810 x 1321	43	
Trolleys for sheet material	4445	500	200	1500 x 400	1500 x 710 x 1510	59	



4463 | 4463-1* | 4465 | 4465-1*



4363 | 4365



3012 - 9016



Pallet feet 2021



Trolleys for sheet material

4463 | 4463-1
4465 | 4465-1

Up to 1200 kg capacity

Welded sectional and tubular steel, powder coated, with wooden platform. 7 positions for insertable tubular supports. Clearance between supports 90 mm.

2 castor wheels and 2 fixed wheels, castors wheels with wheel lock. **Delivery without tubular supports.**

750 kg = TPE tyres, hubs with groove ball bearing

1200 kg = elasticated solid-rubber tyres, blue-grey, "track-less", hubs with ball bearings.

Loading height: 295 mm

Sheet material stands

4363 | 4365

1200 kg capacity

Welded sectional and tubular steel, powder coated, with wooden platform. 4 rubber feet. 7 positions for insertable tubular supports. **Delivery without tubular supports.** Clearance between tubular supports 90 mm.

One face end fitted with 6-piece pick-up roller.

Pallet feet 2021

As accessory for sheet material stands. Access 100 mm, for pallet truck or fork-lift access.

*Can not be fitted with FIXSTOP.

	Order no.	Capacity kg	Wheel-Ø mm	Platform size L x W mm	Outside dimensions L x W x H mm	Net weight kg
Sheet material trolleys for insertable tubular supports (without tubular supports)	4463	750	200	1200 x 800	1320 x 800 x 295	41
	4463-1*	1200	200	1200 x 800	1320 x 800 x 295	46
	4465	750	200	1600 x 800	1720 x 800 x 295	60
	4465-1*	1200	200	1600 x 800	1720 x 800 x 295	66
Sheet material stands (without tubular supports)	4363	1200	-	1200 x 800	1365 x 800 x 100	45
	4365	1200	-	1600 x 800	1765 x 800 x 100	51

	Order no.	Length mm	Height mm	Net weight kg
Insertable tubular supports for sheet material trolleys and for sheet material stands	3012	1200	300	5
	6012	1200	600	6
	9012	1200	900	7,5
	3016	1600	300	6
	6016	1600	600	7
	9016	1600	900	8,5
Pallet feet	2021	-	-	6

Accessories
on pages 183-185



Glass panel trolleys and trolleys for sheet material

for safe transport of glass panels, wood or plastic panels as well as complete windows or doors.

Trolleys for sheet material. Welded sectional and tubular steel. Powder coated blue RAL 5007.

2 swivel and 2 fixed-wheel castors, elasticated solid rubber tyres, blue-grey „trackless“, hubs with ball bearings.

Swivel castors with wheel locks.

For up to 1200 kg capacity.

4454 | 4455 | 4456

One-sided.

Fitted with rubber strip on one side only.

4474 | 4475 | 4476

Double-sided.

Fitted with rubber strip on two sides.



4454 | 4455 | 4456



4474 | 4475 | 4476

	Order no.	Capacity kg	Wheel-Ø mm	Outside dimensions L x W x H mm	Loading surface L x W mm	Support height mm	Net weight kg	
Sheet material trolleys (one-sided)	4454	1200	200	1276 x 800 x 1788	1276 x 430	1450	66	
	4455	1200	200	1676 x 800 x 1788	1676 x 430	1450	74	
	4456	1200	200	2076 x 800 x 1788	2076 x 430	1450	99	
Sheet material trolleys (double-sided)	4474	1200	200	1276 x 800 x 1783	1276 x 2x 230	1450	72	
	4475	1200	200	1676 x 800 x 1783	1676 x 2x 230	1450	80	
	4476	1200	200	2076 x 800 x 1783	2076 x 2x 230	1450	103	

TROLLEYS FOR LONG GOODS

Application:

Agile trolleys for transporting long goods such as pipes, profiles, bars, rods etc. Capacity 1.5 - 3 tons.

Removable stanchions:

For simple loading and unloading.



Manoeuvrable:

Can be turned on the spot due to 4 swivel castors or diamond-shaped wheel layout.

Flooring-friendly:

Trackless tyres are suitable even for sensitive flooring.



Trolleys for long goods

Sectional steel construction, with insertable tubular steel stanchions, powder coated.

2110

Platform of anti-slipping, water-proof plywood. 4 heavy duty castor wheels, elasticated solid rubber tyres, blue-grey „trackless“, hubs with ball bearings. 2 castors with wheel lock.



2110

2111

2 cradles, centre clear for crane or fork-lift loading. Rhombic arrangement of wheels, on centre 2 fixed wheels, at each end 1 castor wheel with polyurethane tyre 200 x 50 mm. Hubs with ball bearings. Wheel lock on centre axle.



2111

2113

2 cradles, centre clear for crane or fork-lift loading. Wheels: on centre axle elasticated solid rubber tyres 360 x 75 mm, at each end 1 castor wheel with elasticated solid rubber tyre 200 x 50 mm, blue-grey „trackless“. Wheel lock on centre axle.



2113

2123

As 2113, but wheels with polyurethane tyre.



2123

	Order no.	Capacity kg	Outside dimensions L x W x H mm	Loading height mm	Usef. length of stanchions mm	Clear width mm	Tyres mm	Net weight kg
Trolleys for long goods	2110	1500	700 x 700 x 895	338	550	510	200 x 50	61
	2111	1500	2000 x 600 x 850	350	500	500	200 x 50	74
	2113	2500	2500 x 700 x 920	420	500	600	360 x 75 / 200 x 50	175
	2123	3000	2500 x 700 x 920	420	500	600	360 x 75 / 200 x 50	178

SHEET METAL DUMP TRUCKS | SELF-TILTING BOXES | TIPPING CONTAINERS

Uncompromising quality:

High-quality sheet steel welded oil-tight by robot, shot-blasted, top finish by means of powder coating.

Safety and handling:

Separate, ergonomically arranged handles for pushing and tilting. 4 castors for a safe stand in any situation. Equipped as standard with TOTALSTOP-central brake system for safe tipping operation.



Future-proof:

Drainage tap and filter can be easily retrofitted at low cost.





Sheet metal dump trucks

4701 - 4703 | 4701/7016 - 4703/7016

Sheet metal dump trucks made of 2 mm thick steel sheet, with double-folded top rim. Welded oil-tight.

Chassis made of 3 mm thick canted steel sheet, with integrated stacker pockets. Kickplate and tilt lock, tubular steel handle. Powder coated blue RAL 5007 or anthracite RAL 7016.

Fitted with 2 swivel and 2 fixed-wheel castors, TPE tyres 200 x 40 mm, hubs with groove ball bearing.

Equipped as standard with TOTALSTOP - central brake system on swivel castors.

Suitable for pushing and for stacking.



4701 | 4701/7016



4702 | 4702/7016 - 4704 | 4704/7016

4704 | 4704/7016

Fitted with 2 swivel and 2 fixed-wheel castors, elasticated solid rubber tyres 200 x 50 mm, blue-grey „trackless“, hubs with ball bearings.

Equipped as standard with TOTALSTOP - central brake system on swivel castors.

Suitable for pushing and for stacking.

Tilting process starts manually. For emptying with a forklift or with heavy loading we recommend a self-tilting box or a tipping container.



Safety chain
As anti-skidding and safety device with tow hook.



TOTALSTOP – central brake system
Equipped as standard on swivel castors.



Drainage tap and filter
With filter to separate liquids from solids. Can be retrofitted.



Accessories:

Drainage tap

Can be retrofitted. With filter to separate liquids from solids. Add an 'A' suffix to the order number of the relevant truck (e.g. 4701A).



Safety chain

As anti-skidding and safety device with tow hook.

Order no. 4707

Dimensions of forklift sleeves		Order no.		Contents litres	A mm	B mm	C mm	D mm
		4701	4701/7016	250	194	203	603	72
		4702	4702/7016	450	194	203	603	72
		4703	4703/7016	600	194	327	727	72
		4704	4704/7016	800	194	577	977	72

Content litres	Capacity kg	Box size L x W x H mm	Outside dimensions L x W x H mm	Dumping edge height in mm	Net weight kg	blue RAL 5007	anthracite RAL 7016
						Order no.	Order no.
250	750	1200 x 652 x 413	1359 x 713 x 780	780	70	4701	4701/7016
450	750	1214 x 669 x 708	1374 x 730 x 1072	733	83	4702	4702/7016
600	750	1321 x 794 x 735	1458 x 855 x 1099	843	95	4703	4703/7016
800	800	1321 x 1044 x 735	1458 x 1105 x 1099	843	118	4704	4704/7016

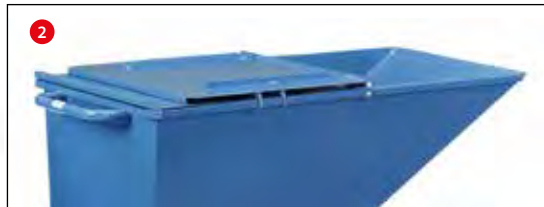

47D1 | 47D1/7016

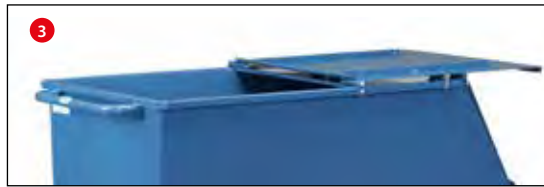

47D2 | 47D2/7016 - 47D4 | 47D4/7016

Cover for sheet metal dump trucks 47D1 - 47D4 47D1/7016 - 47D4/7016

Hinged cover for dump truck, can be opened on 2 sides.

When closed (fig. 1), the cover can be locked in place with spring hooks.

When flipped open, the front part (fig. 2) can be secured with spring hooks to prevent unwanted slamming during tilting.

The flipped open back part (fig. 3) of the cover can also be locked in place.

Folded handle rail on front and back of the cover.

Steel sheet 1.5 mm, internally reinforced with 15 x 3 mm steel strip braces.

No external protrusions to avoid any shearing risk.

Powder coated in blue RAL 5007 or anthracite RAL 7016.

Can be retro-fitted.

Surcharge per dump truck.



Example of use:
Sheet metal dump truck as bin.

	For box size L x W x H mm	Net weight kg	blue RAL 5007	anthracite RAL 7016
			Order no.	Order no.
Cover for sheet material dump truck	1200 x 652 x 413	12,5	47D1	47D1/7016
	1214 x 669 x 708	14,5	47D2	47D2/7016
	1321 x 794 x 735	17,5	47D3	47D3/7016
	1321 x 1044 x 735	22,0	47D4	47D4/7016



Self-tilting boxes
6030 | 6060 | 6090 | 6120

Self-tilting, fully-emptying boxes for tipping bulk goods automatically.

Self-tilting boxes need not to be lifted for emptying. The empty box moves automatically back into loading position.

Sturdy welded 3 mm sheetsteel design, powder coated in RAL 5007 blue.

Standard-fitted robust fork-lift sleeves, anti-roll safety device and tilt lock.

Link chain as anti-skidding and safety device. Traction cable to activate tilting mechanism, operated from fork-lift truck driver's seat.



6030 | 6060 | 6090 | 6120

Set of wheels

2 swivel and 2 fixed-wheel castors made of polyamide, size 200 x 50 mm, fitted underneath the fork-lift sleeves. Swivel castors with wheel locks.

Capacity	Order no.
for 6030/6060	
1500 kg	1567
for 6090/6120	
2500 kg	1568

Drainage tap

With filter to separate liquids from solids. Add 'A' suffix to the order number of the relevant truck (e.g. 6030A). Can be retrofitted.

Replacement safety chain

Safety chain as anti-skidding and safety device with tow hook.

Order no. 4707



Self-tilting box with set of wheels.



Self-tilting box as waste bin with fork-lift.



Drainage tap and filter

With filter to separate liquids from solids. Can be retrofitted.

Dimensions of forklift sleeves	Order no.	Contents litres	A mm	B mm	C mm	D mm
	6030	350	190	192	592	90
	6060	600	190	582	982	90
	6090	900	190	582	982	90
	6120	1200	190	582	982	90

	Order no.	Contents litres	Capacity kg	Box size L x W x H mm	Outside dimensions L x W x H mm	Dumping edge height mm without rollers	Dumping edge height mm with rollers	Net weight kg
Self-tilting boxes	6030	350	1000	1237 x 666 x 703	1294 x 731 x 833	744	981	126
	6060	600	1500	1237 x 1076 x 703	1294 x 1141 x 833	744	981	155
	6090	900	2000	1237 x 1596 x 703	1294 x 1660 x 833	744	989	184
	6120	1200	2500	1699 x 1157 x 997	1755 x 1222 x 1127	1043	1288	230



6230 | 6250 | 6275

Tipping container 6230 | 6250 | 6275

For tipping bulk goods - even extremely light goods automatically.

Particularly low construction.

Tipping containers must be lifted with a fork lift for emptying. By dropping the box to the ground the container will be adjusted automatically and moved back into loading position. Sturdy welded 2 mm sheetsteel design, powder coated in RAL 5007 blue. Standard-fitted fork-lift sleeves, anti-roll safety device and tilt lock. Safety chain as anti-skidding and safety device. Traction cable to activate tilting mechanism, operated from fork-lift truck driver's seat.

Set of wheels

2 swivel and 2 fixed-wheel castors, made of polyamide, size 200 x 50 mm, fitted underneath the fork-lift sleeves. Swivel castors with wheel locks.

Capacity	Order no.
for 6230/6250/6275	
1500 kg	1567

For tipping container with set of wheels the container will not snap in automatically while dropping to the ground.

Drainage tap

With filter to separate liquids from solids. Add 'A' suffix to the order number of the relevant truck (e.g. 6230A). Can be retrofitted.

Replacement safety chain

Safety chain as anti-skidding and safety device.

Order no.	4708
-----------	------



Tipping container with set of wheels.



Tipping container as a waste container with fork-lift.



Drainage tap and filter

With filter to separate liquids from solids. Can be retrofitted.

Dimensions of forklift sleeves	Order no.	Contents litres	A mm	B mm	C mm	D mm
	6230	300	192	82	482	72
	6250	500	192	282	682	72
	6275	750	192	502	902	72

	Order no.	Contents litres	Capacity kg	Box size L x W x H mm	Outside dimensions L x W x H mm	Dumping edge height mm without rollers	Dumping edge height mm with rollers	Net weight kg
Tipping containers	6230	300	750	1088 x 630 x 498	1313 x 690 x 576	418	655	78
	6250	500	1000	1164 x 831 x 598	1389 x 890 x 676	519	756	86
	6275	750	1000	1164 x 1241 x 598	1390 x 1300 x 676	519	756	108

PALLET TRANSPORT



Catch corners:
Simple loading and secure hold while driving.



Practical and good:
For flat pallets and pallet cages.
Sturdy steel structure, manufactured to the highest craftsmanship standards.

Castor equipment:
TPE, polyamide, elastic solid rubber or polyurethane tyres, all non-marking and with wheel locks.



22501



22799 | 22800 | 22801 | 22802



22879 | 22880 | 22881 | 22882



22849 | 22850 | 22851 | 22852



22809 | 22810 | 22811 | 22812

Light pallet dollies

22501*

For pallets and lattice boxes.

500 kg capacity.

2 swivel and 2 fixed-wheel castors 160 x 40 mm, TPE tyres, castors with wheel lock.

Flat steel frame with down-stand beam, without catch corners, powder coated, blue RAL 5007. Because of the decreased bearing profile (20 mm) the revolving frame securely takes the pallets and lattice boxes.

Pallet dollies

For pallets and lattice boxes.

Sturdy sectional steel construction with 4 catch corners for stacking, powder coated, blue RAL 5007.

2 swivel and 2 fixed-wheel castors. Castors with wheel lock.

22799 | 22800

22801 | 22802

Capacity 750 kg

TPE tyres 200 x 40 mm, hubs with ball bearings. Very low starting, rolling and swivelling resistance. Tyres are non-marking (trackless). Low-noise running on even flooring.

22879 | 22880

22881 | 22882

Capacity 1050 kg

Polyamide wheels 200 x 50 mm, hubs with roller bearings. Low rolling resistance, high chemical resistance, non-marking. Road noise.

22849 | 22850

22851 | 22852

Capacity 1050 kg

Polyurethane tyres 200 x 50 mm, hubs with ball bearings. Very low rolling resistance, smooth running, no road noise.

22809 | 22810

22811 | 22812

Capacity 1200 kg

Elasticated solid rubber tyres 200 x 50 mm, blue-grey „trackless“, hubs with ball bearings. Low rolling resistance, easy movement, no road noise.

* All special equipments on page 128/129 (stacking frames, tubular push handle, self-locking push handle and shaft and tow hitch) are not suitable. FIXSTOP only possible on pallet dollies with TPE.

	Order no.	Capacity kg	Outside dimensions L x W x H mm	Platform size L x W mm	For pallet size L x W mm	Height mm	Net weight kg
Light pallet dolly TPE tyres*	22501*	500	1240 x 830 x 238	1230 x 820	1200 x 800	216	29
Pallet dollies TPE-tyres	22799	750	855 x 655 x 329	810 x 610	800 x 600	282	30
	22800	750	1055 x 855 x 329	1010 x 810	1000 x 800	282	33
	22801	750	1255 x 855 x 329	1210 x 810	1200 x 800	282	34
	22802	750	1255 x 1055 x 329	1210 x 1010	1200 x 1000	282	35
Pallet dollies Polyamide	22879	1050	855 x 655 x 329	810 x 610	800 x 600	282	29
	22880	1050	1055 x 855 x 329	1010 x 810	1000 x 800	282	32
	22881	1050	1255 x 855 x 329	1210 x 810	1200 x 800	282	33
	22882	1050	1255 x 1055 x 329	1210 x 1010	1200 x 1000	282	35
Pallet dollies Polyurethane	22849	1050	855 x 655 x 329	810 x 610	800 x 600	282	30
	22850	1050	1055 x 855 x 329	1010 x 810	1000 x 800	282	32
	22851	1050	1255 x 855 x 329	1210 x 810	1200 x 800	282	33
	22852	1050	1255 x 1055 x 329	1210 x 1010	1200 x 1000	282	35
Pallet dollies Elasticated solid rubber	22809	1200	855 x 655 x 329	810 x 610	800 x 600	282	31
	22810	1200	1055 x 855 x 329	1010 x 810	1000 x 800	282	34
	22811	1200	1255 x 855 x 329	1210 x 810	1200 x 800	282	35
	22812	1200	1255 x 1055 x 329	1210 x 1010	1200 x 1000	282	36



Stacking frames for pallet dollies*

For parking flat pallets and pallet cages at an ergonomically comfortable level.

Angle steel construction with catch corners, sturdy tubular supports with base plates.

Stable support tubes with foot plates, to be inserted into corner sleeves at the stacking frame. Powder coated, blue RAL 5007.

4 sizes: 800 x 600 mm
1000 x 800 mm
1200 x 800 mm
1200 x 1000 mm

3 loading heights:

without pallet dolly:

140 mm
270 mm
370 mm

with pallet dolly:

422 mm
552 mm
652 mm

Stacking frames can be bolted tight with the pallet dolly via base plates and bolting set (included in delivery).



22921



22899-22922



Example of use

Stacking frames for pallet dollies	Order no.	Capacity kg	Platform size L x W mm	For pallet size mm	Loading height mm		Net weight kg
					without pallet dolly	with pallet dolly	
140/422 mm high	22899	1200	810 x 610	800 x 600	140	422	13
	22900	1200	1010 x 810	1000 x 800	140	422	16
	22901	1200	1210 x 810	1200 x 800	140	422	17
	22902	1200	1210 x 1010	1200 x 1000	140	422	18
270/552 mm high	22909	1200	810 x 610	800 x 600	270	552	14
	22910	1200	1010 x 810	1000 x 800	270	552	17
	22911	1200	1210 x 810	1200 x 800	270	552	18
	22912	1200	1210 x 1010	1200 x 1000	270	552	19
370/652 mm high	22919	1200	810 x 610	800 x 600	370	652	15
	22920	1200	1010 x 810	1000 x 800	370	652	18
	22921	1200	1210 x 810	1200 x 800	370	652	19
	22922	1200	1210 x 1010	1200 x 1000	370	652	20

*Stacking frames are not suitable for the pallet dollies 22501 and 22699 - 22702.



22890*

Push handle*

22890

Strong adjustable push handle can be attached at the castor end. The sleeves are welded together with the chassis.

Self-locking push handle

22892

Self-locking push handle for pallet dollies from 800 mm width. For comfortable and ergonomic moving of empty and loaded pallet dollies. Sturdy tubular steel construction with strong support claws. Handle and cross tube with softgrip. In unlocked position movable via two auxiliary rollers.

Utility patent

20 2014 010 367

Shaft and tow hitch*

22894

For the transport with towing vehicles up to 6 km/h. Transports up to 5 pallet dollies possible.

Maximum train weight 2000 kg.

Shaft made of sheet steel. Shaft raises automatically via gas springs into vertical resting position. Robust coupling pin on the fixed-wheel side. Connection via foot operation possible.

Shaft and tow hitch*

22895

For the transport with towing vehicles up to 6 km/h. Transports up to 5 pallet dollies possible.

Maximum train weight 2000 kg.

Shaft made of sheet steel. In resting position shaft can be folded frame. Robust coupling pin on the fixed-wheel side. Connection via foot operation possible.

German Patent

10 2004 061 440

*All accessories are not suitable for the the light pallet dolly 22501. *Optional extras can only be purchased with pallet dollies because they are welded together.*



22892



22894*



22895*



Order no.		
22890*	Push handle*	
22892	Self-locking push handle	
22894*	Shaft and tow hitch*	
22895*	Shaft and tow hitch*	



← Application film

Pallet dollies as tugging train

22601

For pallets and lattice boxes in European standard sizes.

Easy loading and unloading from the side with forklift.

Sturdy sectional steel construction with 4 catch corners for stacking. Powder coated blue RAL 5007.

2 swivel and 2 fixed-wheel castors, with robust steel carriages suitable for tugging trains, wheels with PU tyres on aluminium rims, hubs with precision ball bearings. Swivel castors with wheel locks.

Tyres are non-marking (trackless). Low-noise running on even flooring.

Capacity 1000 kg.

- This coupling system guarantees the best possible directional stability
- Tractors must have front wheel steering and tugging train drawbar!

- Max. 5 pallet dollies per train
- Max. train speed 6 km/h
- Max. train weight 3000 kg

German patent
10 2016 108 182

Warranty
for tugging trains 3 years.



22601



Detail tow hitch and shaft

On the swivel wheel side there is a strong coupling pin Ø 25 mm with leading jaws and automatic safety lock. Coupling height 205 mm.

Self-securing flat steel drawbar on the fixed-wheel side. Drawbar eye Ø 26.5 mm. Comfortable foot operation. Automatically rebounds into vertical resting position by means of gas spring.

	Order no.	Capacity kg	Outside dimensions L x W x H mm	Platform size L x W mm	For pallet size L x W mm	Height mm	Net weight kg
Pallet dollies as tugging train	22601	1000	1327 x 855 x 783	1210 x 810	1200 x 800	290	50

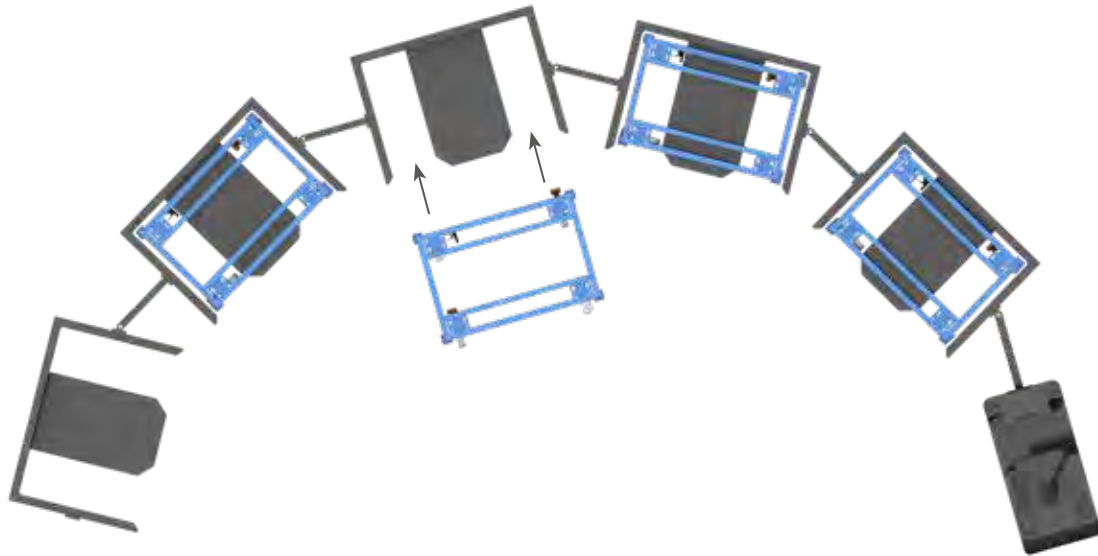

Transport on standard tugging trains

Pallet dollies for standard tugging trains

23881 | 23882

Capacity 1050 kg

Suitable for transport on standard tugging trains. Resilient angle steel design with corner supports.

Powder coated in blue RAL 5007. 4 swivel castors with polyamide wheels 200 x 50 mm white, hubs with precision ball bearings. 2 swivel castors with full locking device in the lead, diagonal layout.

Ground clearance: 235 mm

23891 | 23892

Capacity 1050 kg

Construction as in 23881, but 1 castor is electrically conductive, black polypropylene wheel body, hub with precision ball bearings.

Ground clearance: 235 mm



23881 | 23882



23891 | 23892



23990

Extra charge for 1 swivel castor with directional locking device instead of 1 swivel castor without locking device.

4 x 90 degrees locking provides good directional stability in longitudinal and transversal direction. Fixed operating lever underneath the frame, not protruding. To be operated from the long side. Easy reach in any castor position.

German patent 10 2016 110 300.4



23991

Extra charge for 2 swivel castors with fixed locking device operating levers instead of the swivel castors with pivoting operating levers.

Fixed operating levers underneath the frame, not protruding. To be operated from the long side. Easy reach in any castor position. Ground clearance increased to 237 mm, overall height to 282 mm.

	Order no.	Capacity kg	Outside dimensions L x W x H mm	Platform size L x W mm	For pallet size L x W mm	Loading height mm	Net weight kg
Pallet dollies for standard tugging trains	23881	1050	1255 x 855 x 327	1210 x 810	1200 x 800	280	34
	23882	1050	1255 x 1055 x 327	1210 x 1010	1200 x 1000	280	34
	23891	1050	1255 x 855 x 327	1210 x 810	1200 x 800	280	34
	23892	1050	1255 x 1055 x 327	1210 x 1010	1200 x 1000	280	34

Order no.		New loading and total height mm
23990	1 swivel castor with directional locking device	-
23991	2 swivel castors with fixed locking device operating levers	282/329

HAND CARTS

Large wheels:

With high-quality tyres for smooth running and long service life.



Outdoor:

Hot-dip galvanised with quintet pattern aluminium plate for outdoor use.



Drawbar:

Ergonomic safety handle with soft-grip cover, damped retraction and automatic braking system.



Hand carts 4091L | 4092L

Light hand cart
Made of tubular steel, welded and powder coated blue RAL 5007.
Shaft can be screwed on. Platform made of water-resistant plywood boards.
Wheels with pneumatic tyres, hubs with roller bearings.
Flat packed for easy self assembly.

4101L | 4102L

Light hand cart with plastic tray. Construction as 4091L | 4092L, but without platform made of water-resistant plywood boards.
Red plastic tray:
4101L: 90 liters content, L x W x H = 715 x 420 x 320 mm
4102L: 200 liters content, L x W x H = 990 x 665 x 476 mm

6091L

Construction as 4091L, but hot-dip galvanised. Suitable for outdoor area.

6101L

Construction as 4101L, but hot-dip galvanised. Suitable for outdoor area.



Bicycle coupling 1297

For hand carts 4091L, 4092L, 4101L and 4102L. Consisting of ball coupling and adapter for seat posts with a diameter of 26 to 31 mm and drawbar with spherical bracket. Load capacity max. 40 kg, fifth wheel load max. 4 kg.
Can not be retrofitted.

Bicycle coupling 1297

For hand carts 6091L and 6101L. Construction hot-dip galvanised.
Can not be retrofitted.

Reflectors

For hand carts with bicycle couplings, foil reflector strips are included free of charge. 2 x red and 4 x white.

On request with solid rubber tyres, deliverable without surcharge.

Please replace the „L“ in the order number of the hand cart by a „V“.

For surcharge PU tyres see page 186.

	Order no.	Capacity kg	Platform size L x W mm	Outside dimensions L x W x H mm	Pneumatic tyres mm	Net weight kg
Hand carts with board	4091L	200	690 x 356	1381 x 596 x 777	260 x 85	10
	4092L	200	835 x 458	1524 x 682 x 777	260 x 85	13,5
Hand carts with plastic tray	4101L	200	632 x 332	1401 x 596 x 777	260 x 85	9,5
	4102L	200	750 x 425	1566 x 682 x 777	260 x 85	17
Hand carts with board	6091L	200	690 x 356	1381 x 596 x 777	260 x 85	11
Hand carts with plastic tray	6101L	200	632 x 332	1401 x 596 x 777	260 x 85	10,5
Coupling	1297		for hand carts 4091 4092 4101 4102 6091 6101			

**Hand carts****4103L | 4104L | 4105L**

Hand cart, made of tubular steel, welded and powder coated blue RAL 5007.

Rail 180/250 mm high. Screw-on drawbar with safety handle and skin-friendly softgrip cover, Platform made of water-resistant plywood boards.

Wheels with pneumatic tyres, hubs with roller bearings.

**4103L | 4104L | 4105L****4107L | 4108L | 4109L****4107L | 4108L | 4109L**

Construction as above, but with 4 waterproof box superstructure made of plywood.

On request with solid rubber tyres, without surcharge.

**6103L | 6104L | 6105L****Outdoor handcart****6103L | 6104L | 6105L****6103P | 6104P | 6105P****For outdoor use.**

Welded from tubular steel, hot-dip galvanized. Platform made of quintet pattern aluminium plate. Railing 180/250 mm high with strong tubular struts.

Screw-on drawbar with safety handle and skin-friendly softgrip cover.

Large tyres with fibreglass-reinforced plastic wheel rims, optionally with pneumatic or puncture-proof polyurethane tyres, hubs with roller bearings. Screwed wheel attachment for easy wheel change.

**Bicycle coupling 1292**

Mounting kit consisting of ball coupling and adapter for seat posts with a diameter of 26 to 31 mm and spherical bracket with bolt-on plates on standard drawbar. Load capacity max. 40 kg, fifth wheel load max. 4 kg.

Can be retrofitted.

**Reflectors**

For hand carts with bicycle couplings, foil reflector strips are included free of charge. 2 x red and 4 x white.

On request with solid rubber tyres, deliverable without surcharge.

Please replace the „L“ in the order number of the hand cart by a „V“.

For surcharge PU tyres see page 186.

	Order no.	Capacity kg	Platform size L x W mm	Outside dimensions L x W x H mm	Size of wheel mm	Tyres	Net weight kg
Hand carts, 1 axle	4103L	300	795 x 445	1476 x 691 x 730	260 x 85	Pneumatic	18
	4104L	400	845 x 545	1526 x 832 x 801	400 x 100	Pneumatic	22
	4105L	400	1145 x 545	1826 x 832 x 801	400 x 100	Pneumatic	25
Hand carts with 4 boards, 1 axle	4107L	300	795 x 445	1476 x 691 x 730	260 x 85	Pneumatic	21
	4108L	400	845 x 545	1526 x 832 x 801	400 x 100	Pneumatic	25
	4109L	400	1145 x 545	1826 x 832 x 801	400 x 100	Pneumatic	31
Outdoor-Hand carts, galvanized	6103L	300	795 x 445	1475 x 682 x 736	260 x 85	Pneumatic	20
	6104L	400	845 x 545	1525 x 840 x 811	400 x 100	Pneumatic	24
	6105L	400	1145 x 545	1825 x 840 x 811	400 x 100	Pneumatic	27
Outdoor-Hand carts, galvanized	6103P	300	795 x 445	1475 x 682 x 736	260 x 85	Polyurethane	22
	6104P	400	845 x 545	1525 x 840 x 811	400 x 100	Polyurethane	27
	6105P	400	1145 x 545	1825 x 840 x 811	400 x 100	Polyurethane	30
Coupling	1292	for hand carts 4103L 4104L 4105L 4107L 4108L 4109L 6103L 6104L 6105L					



4001L | 4002L



4021L | 4022L



4051L | 4052L



4122L | 4124L

Hand carts 4001L | 4002L

Made of tubular steel, welded and powder coated blue RAL 5007.

Platform made of water-resistant plywood.

Bogie steering with shaft and handle.

Wheels with pneumatic tyres, hubs with roller bearings.

Shaft with safety handle and with an automatic damped retraction in resting position.

With automatic braking system effective on the front wheels.

4021L | 4022L

Construction as above, but with two ends 300 mm high. Tubular steel frame with water-resistant plywood.

4051L | 4052L

Construction as above, but with two insertable sides made of water-resistant plywood, 220 mm high.

4122L | 4124L

Hand cart, made of tubular steel, welded and powder coated blue RAL 5007.

Rail 180/250 mm high, platform, sides and ends made of water-resistant plywood.

Bogie steering with shaft and handle.

Wheels with pneumatic tyres, hubs with roller bearings.

Shaft with safety handle and with an automatic damped retraction in resting position.

With automatic braking system effective on the front wheels.

On request with solid rubber tyres, deliverable without surcharge.

Please replace the „L“ in the order number of the hand cart by a „V“.

For surcharge PU tyres see page 186.

	Order no.	Capacity kg	Platform size L x W mm	Outside dimensions L x W x H mm	Shelf height mm	Pneumatic tyres mm	Net weight kg
Hand carts with platform	4001L	500	1060 x 600	1272 x 609 x 1192	308	260 x 85	30
	4002L	500	1260 x 700	1472 x 709 x 1192	308	260 x 85	38
Hand carts with sides	4021L	500	1000 x 600	1272 x 609 x 1192	308	260 x 85	35
	4022L	500	1200 x 700	1472 x 709 x 1192	308	260 x 85	45
Hand carts with 4 sides	4051L	500	1000 x 550	1272 x 609 x 1192	308	260 x 85	39
	4052L	500	1200 x 650	1472 x 709 x 1192	308	260 x 85	50
Hand carts with 4 sides	4122L	400	945 x 545	1204 x 600 x 1185	312	260 x 85	36
	4124L	400	1145 x 645	1375 x 700 x 1185	312	260 x 85	44

HAND TRUCKS

Drawbar:

Safety drawbar with automatic damped retraction in resting position. Handle with skin-friendly softgrip cover, pressure-relieving and insulating.

Versions:

Optionally available with sturdy and attractive drop sides and wire mesh sides.

**Bogey steering:**

With crown gear.

Platform:

Covered with anti-slipping, waterproof plywood.

Large wheels:

With high-quality solid rubber or pneumatic tyres on fibreglass-reinforced plastic wheel rims with roller bearings for smooth running and long service life.



6403V | 6403L | 6404V | 6404L | 6405V | 6405L | 6406V | 6406L



6453V | 6453L | 6454V | 6454L | 6455V | 6455L | 6456V | 6456L

**Hand trucks
Modular system**

Made of welded sectional steel, powder coated blue RAL 5007. Surface durably protected, resistant to impact and scratches.

4 tubular sleeves at corners.

Boogie steered by crown gear, scissors-shaped shaft with safety handle with soft rubber grip and with an automatic damped retraction in resting position.

Platform of anti-slipping, waterproof plywood.

Wheels optionally with solid rubber or pneumatic tyres, hubs with roller bearings. With automatic braking system effective on the front wheels.

Hand truck with boards

250/325 mm high, 3 sides tilting, front end fixed. Powder coated tubular steel frame with waterproof plywood platform.

Platform size:
length – 60 mm
width – 60 mm

Traction eye

On shaft.



Interior-Ø 32 mm.

Add „Z” to order no. of the trolley.

Can not be retrofited.

Coupling

At rear.



Order no. 1442

	Order no.	Capacity kg	Platform size L x w mm	Outside dimensions L x W x H mm	Loading height mm	Solid rubber tyres mm	Pneumatic tyres mm	Net weight kg
Platform	6403V	750	1200 x 800	1545 x 800 x 1125	420	260 x 56	–	66
	6403L	750	1200 x 800	1545 x 800 x 1130	420	–	260 x 85	62
	6404V	1000	1200 x 800	1545 x 800 x 1190	490	400 x 74	–	88
	6404L	1000	1200 x 800	1545 x 800 x 1200	490	–	400 x 100	67
	6405V	1000	1600 x 900	1945 x 900 x 1190	490	400 x 74	–	98
	6405L	1000	1600 x 900	1945 x 900 x 1200	490	–	400 x 100	77
	6406V	1250	2000 x 1000	2345 x 1000 x 1190	490	400 x 74	–	134
	6406L	1250	2000 x 1000	2345 x 1000 x 1200	490	–	400 x 100	113
with boards	6453V	750	1200 x 800	1560 x 825 x 1125	420	260 x 56	–	81
	6453L	750	1200 x 800	1560 x 825 x 1130	420	–	260 x 85	77
	6454V	1000	1200 x 800	1560 x 825 x 1190	490	400 x 74	–	102
	6454L	1000	1200 x 800	1560 x 825 x 1200	490	–	400 x 100	80
	6455V	1000	1600 x 900	1960 x 925 x 1190	490	400 x 74	–	118
	6455L	1000	1600 x 900	1960 x 925 x 1200	490	–	400 x 100	97
	6456V	1250	2000 x 1000	2360 x 1025 x 1190	490	400 x 74	–	158
	6456L	1250	2000 x 1000	2360 x 1025 x 1200	490	–	400 x 100	137



Hand truck with ends and sides made of wire lattice

Modular system

6433V - 6436L

600 mm high, sides screwed on platform, Sides mountable and removable. Tubular steel frame with welded wire lattice 40 x 40 x 4 mm, powder coated blue RAL 5007.

Platform size =

length – 65 mm,
width – 5 mm.

6443V - 6446L

As 6433V - 6436L, but 1000 mm high.

Traction eye

On shaft.



Interior-Ø 32 mm.

Add „Z“ to order no. of the trolley.

Can not be retrofited.

Coupling

At rear.



Order no. 1442



6433V | 6433L | 6434V | 6434L | 6435V | 6435L | 6436V | 6436L



6443V | 6443L | 6444V | 6444L | 6445V | 6445L | 6446V | 6446L

	Order no.	Capacity kg	Platform size L x w mm	Outside dimensions L x W x H mm	Loading height mm	Solid rubber tyres mm	Pneumatic tyres mm	Net weight kg
with sides and ends 600 mm high	6433V	750	1200 x 800	1550 x 850 x 1125	420	260 x 56	–	97
	6433L	750	1200 x 800	1550 x 850 x 1130	420	–	260 x 85	92
	6434V	1000	1200 x 800	1550 x 850 x 1190	490	400 x 74	–	116
	6434L	1000	1200 x 800	1550 x 850 x 1200	490	–	400 x 100	98
	6435V	1000	1600 x 900	1950 x 950 x 1190	490	400 x 74	–	133
	6435L	1000	1600 x 900	1950 x 950 x 1200	490	–	400 x 100	115
	6436V	1250	2000 x 1000	2350 x 1050 x 1190	490	400 x 74	–	166
	6436L	1250	2000 x 1000	2350 x 1050 x 1200	490	–	400 x 100	142
with sides and ends 1000 mm high	6443V	750	1200 x 800	1550 x 850 x 1415	420	260 x 56	–	108
	6443L	750	1200 x 800	1550 x 850 x 1420	420	–	260 x 85	103
	6444V	1000	1200 x 800	1550 x 850 x 1480	490	400 x 74	–	113
	6444L	1000	1200 x 800	1550 x 850 x 1490	490	–	400 x 100	108
	6445V	1000	1600 x 900	1950 x 950 x 1480	490	400 x 74	–	148
	6445L	1000	1600 x 900	1950 x 950 x 1490	490	–	400 x 100	128
	6446V	1250	2000 x 1000	2350 x 1050 x 1480	490	400 x 74	–	174
	6446L	1250	2000 x 1000	2350 x 1050 x 1490	490	–	400 x 100	155

SACK TRUCKS

Safety handle:

Sturdy handle with safety loop:
Protects the hands from abrasions
and bruises.

Construction:

Inclined frame structure to support
bags and round goods.



Powder-coated:

Surface shot-blasted and powder-
coated. For long service life and
permanent good looks.



Wheel attachment:

The fetra wheel in an own design
with a displaced hub, no protrusion.
Bolted wheel attachment enables
easy wheel changes.



Shovel:

Available in various sizes and
exchangeable.



Sack trucks

Handy tubular steel trucks with steel sheet blades, sturdy welded construction, blue RAL 5007. Safety grips. Steel sheet front shovel mountable, therefore exchangeable. Optionally solid rubber, pneumatic tyres or puncture-proof polyurethane tyres on synthetic rims, hubs with roller bearings.

Flat packed delivery.

Utility patent

20 2004 010 071.1



B1115L



B1116L



B1215L



B1216L

	Order no.	Capacity kg	Height mm	Blade depth mm	Blade width mm	Total width mm	Tyre size mm	Tyres	Net weight kg
Sack trucks	B1115V	250	1150	150	400	590	260 x 56	solid rubber	15
	B1115L	250	1150	150	400	590	260 x 85	pneumatic	12
	B1115P	250	1150	150	400	590	260 x 85	polyurethane	12,7
	B1116V	250	1150	300	480	590	260 x 56	solid rubber	18
	B1116L	250	1150	300	480	590	260 x 85	pneumatic	15
	B1116P	250	1150	300	480	590	260 x 85	polyurethane	15,7
	B1215V	350	1200	150	450	620	260 x 56	solid rubber	19
	B1215L	350	1200	150	450	620	260 x 85	pneumatic	16
	B1215P	300	1200	150	450	620	260 x 85	polyurethane	16,7
	B1216V	350	1200	300	480	620	260 x 56	solid rubber	21
	B1216L	350	1200	300	480	620	260 x 85	pneumatic	18
	B1216P	300	1200	300	480	620	260 x 85	polyurethane	18,7
Handle	1762	with safety loop for tube-Ø 27 mm							

STACKING TRUCKS



Handling:
Curved top bar and transversal struts. For safe transport of round items such as rolls, cans, buckets etc.

Powder-coated:
Surface shot-blasted and powdercoated. For long service life and permanent good looks.



Safety handle:
Sturdy handle with safety loop:
Protects the hands from abrasions and bruises.



Plastic skids:
Easily and at low cost replaceable. The ends of the skids are reinforced and adjoin full flat on the pipe bend.

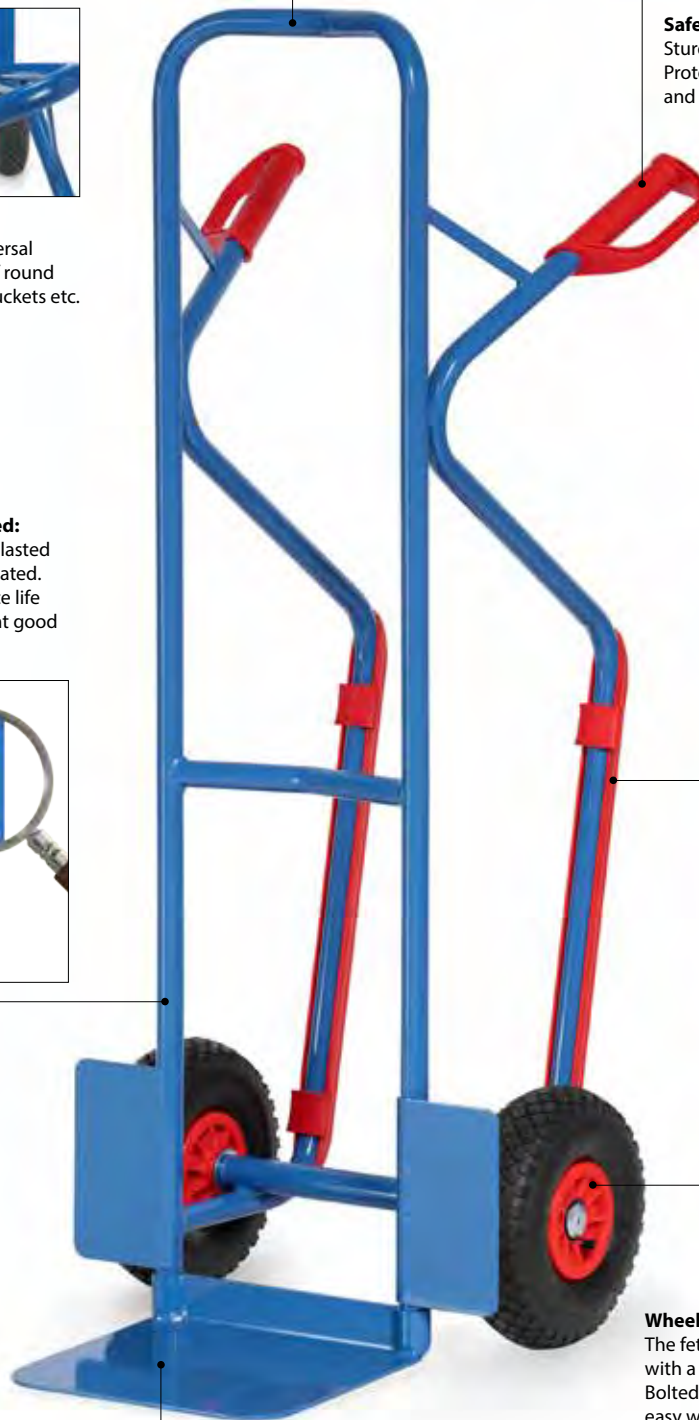

Shovel:
Available in various sizes and exchangeable.

Wheel attachment:
The fetra wheel in an own design with a displaced hub, no protrusion. Bolted wheel attachment enables easy wheel changes.





Stacking trucks

Handy tubular steel trucks with steel sheet blades, sturdy welded construction, blue RAL 5007. Safety grips. Steel sheet front shovel mountable, therefore exchangeable.

Optionally solid rubber, pneumatic tyres or puncture-proof polyurethane tyres on synthetic rims, hubs with roller bearings.

Curved top bar and transversal struts. For safe transport of circular items such as rolls, cans, buckets etc.

Flat packed delivery.

Utility patent

20 2004 010 071.1



Example of use pneumatic + solid rubber



B1125L



B1325L



B1326L



Solid rubber tyres



Pneumatic-tyres



PU-tyres



Clamping band 1722G

See page 186.

	Order no.	Capacity kg	Height mm	Blade depth mm	Blade width mm	Total width mm	Tyre size mm	Tyres	Net weight kg
Stacking trucks	B1125V	200	1150	250	320	570	260 x 56	solid rubber	14
	B1125L	200	1150	250	320	570	260 x 85	pneumatic	11
	B1125P	200	1150	250	320	570	260 x 85	polyurethane	11,7
	B1325V	300	1300	250	320	580	260 x 56	solid rubber	17
	B1325L	300	1300	250	320	580	260 x 85	pneumatic	14
	B1325P	300	1300	250	320	580	260 x 85	polyurethane	14,7
	B1326V	300	1300	300	480	580	260 x 56	solid rubber	19
	B1326L	300	1300	300	480	580	260 x 85	pneumatic	16
	B1326P	300	1300	300	480	580	260 x 85	polyurethane	16,7
Handle	1762	with safety loop for tube-Ø 27 mm							



B1330L + B1330V



B1331L



B1327L



B1328L

Stacking trucks

Handy tubular steel trucks with steel sheet blades, sturdy welded construction, blue RAL 5007. Safety grips. Steel sheet front shovel mountable, therefore exchangeable.

Optionally solid rubber, pneumatic tyres or puncture-proof polyurethane tyres on synthetic rims, hubs with roller bearings.

Curved top bar and transversal struts. For safe transport of circular items such as rolls, cans, buckets etc.

Flat packed delivery.

Utility patent
20 2004 010 071.1

B1330L | B1331L

With replaceable synthetic rockers.

Wear parts

Plastic skids

1753

1 set with clips.
See page 186.

	Order no.	Capacity kg	Height mm	Blade depth mm	Blade width mm	Total width mm	Tyre size mm	Tyres	Net weight kg
Stacking trucks	B1330V	300	1300	250	320	580	260 x 56	Solid rubber	18
	B1330L	300	1300	250	320	580	260 x 85	Pneumatic	15
	B1330P	300	1300	250	320	580	260 x 85	polyurethane	15,7
	B1331V	300	1300	300	480	580	260 x 56	Solid rubber	20
	B1331L	300	1300	300	480	580	260 x 85	Pneumatic	17
	B1331P	300	1300	300	480	580	260 x 85	polyurethane	17,7
	B1327V	300	1600	250	320	580	260 x 56	Solid rubber	18
	B1327L	300	1600	250	320	580	260 x 85	Pneumatic	15
	B1327P	300	1600	250	320	580	260 x 85	polyurethane	15,7
	B1328V	300	1600	300	480	580	260 x 56	Solid rubber	20
	B1328L	300	1600	300	480	580	260 x 85	Pneumatic	17
	B1328P	300	1600	300	480	580	260 x 85	polyurethane	17,7
Handle	1762	with safety loop for tube-Ø 27 mm							

Accessories on page 186



Alu-Stacking trucks

Aluminium trucks made of tubular aluminium with alu blades, very light and handy to use. Aluminum sheet shovel mountable, therefore exchangeable.

Optionally solid rubber, pneumatic tyres or puncture-proof polyurethane tyres on synthetic rims, hubs with roller bearings.

Curved top bar and transversal struts. For safe transport of circular items such as rolls, cans, buckets etc.

Flat packed delivery.



Example of use pneumatic + solid rubber



A1125L



A1115L



A1116L



Solid rubber tyres



Pneumatic-tyres



PU-tyres



Clamping band 1722G

See page 186.

	Order no.	Capacity kg	Height mm	Blade depth mm	Blade width mm	Total width mm	Tyre size mm	Tyres	Net weight kg
Alu-Stacking trucks	A1125V	150	1150	250	320	570	260 x 56	solid rubber	12
	A1125L	150	1150	250	320	570	260 x 85	pneumatic	9
	A1125P	150	1150	250	320	570	260 x 85	polyurethane	9,7
	A1115V	150	1150	150	400	590	260 x 56	solid rubber	11
	A1115L	150	1150	150	400	590	260 x 85	pneumatic	8
	A1115P	150	1150	150	400	590	260 x 85	polyurethane	8,7
	A1116V	150	1150	300	480	590	260 x 56	solid rubber	12
	A1116L	150	1150	300	480	590	260 x 85	pneumatic	9
	A1116P	150	1150	300	480	590	260 x 85	polyurethane	9,7
Handle	1762	with safety loop for tube-Ø 27 mm							



A1330L + A1330V

Alu-Stacking trucks

Aluminium trucks made of tubular aluminium with alu blades, very light and handy to use. Aluminum sheet shovel mountable, therefore exchangeable.

Optionally solid rubber, pneumatic tyres or puncture-proof polyurethane tyres on synthetic rims, hubs with roller bearings.

Curved top bar and transversal struts. For safe transport of circular items such as rolls, cans, buckets etc.

Flat packed delivery.

A1330L | A1331L

With replaceable synthetic rockers.

Wear parts

Plastic skids 1753

1 set with clips.



A1331L



A1325L



A1326L

	Order no.	Capacity kg	Height mm	Blade depth mm	Blade width mm	Total width mm	Tyre size mm	Tyres	Net weight kg
Alu-Stacking trucks	A1330V	200	1300	250	320	590	260 x 56	solid rubber	12
	A1330L	200	1300	250	320	590	260 x 85	pneumatic	9
	A1330P	200	1300	250	320	590	260 x 85	polyurethane	9,7
	A1331V	200	1300	300	480	590	260 x 56	solid rubber	13
	A1331L	200	1300	300	480	590	260 x 85	pneumatic	10
	A1331P	200	1300	300	480	590	260 x 85	polyurethane	10,7
	A1325V	200	1300	250	320	590	260 x 56	solid rubber	12
	A1325L	200	1300	250	320	590	260 x 85	pneumatic	9
	A1325P	200	1300	250	320	590	260 x 85	polyurethane	9,7
	A1326V	200	1300	300	480	590	260 x 56	solid rubber	13
	A1326L	200	1300	300	480	590	260 x 85	pneumatic	10
	A1326P	200	1300	300	480	590	260 x 85	polyurethane	10,7
Handle	1762	with safety loop for tube-Ø 27 mm							



Stairway trucks

Tubular steel, with lifting blades made of steel sheet, sturdy welded construction, powder coated, blue RAL 5007. Safety handles. Steel sheet front shovel mountable.

Flat packed delivery.

Utility patent

20 2004 010 071.1

Curved top bar and transversal struts. For safe transport of circular items such as rolls, cans, buckets etc.

TK1325 | TK1326

With 2 three-armed wheel spiders, each equipped with 3 TPE tyres 160 mm Ø, hubs with ball bearings.

TK1327 | TK1328

With 2 pneumatic tyres on synthetic rims, hubs with roller bearings and 2 five-armed wheel spiders, each equipped with 5 TPE wheels 125 mm Ø, hubs with bush bearings.

Three-arm wheel spider

With 2 three-armed wheel spiders, advantageous for frequent use on stairs and acceptable ground conditions on flat surface.

Five-arm wheel spider

With 2 pneumatic tyres and 2 five-armed wheel spiders, advantageous for frequent use on bad ground conditions on flat surface and occasional use on stairs.

Wear parts

**Handle
1762**

With safety loop for tube-Ø 27 mm. See page 186.



TK1325



TK1326



TK1327



TK1328



Three-arm wheel spider
TK1325 | TK1326



Five-arm wheel spider
TK1327 | TK1328



Wheel spider lock 1770
Add-on kit for stairway trucks
TK1325 and TK1326. For easy
moving on 2 wheels on flat
surface. Easy self assembly.



Wheel-fixing
screwed wheel fixing, easy
wheel change.

	Order no.	Capacity kg	Height mm	Lifting blade depth mm	Lifting blade width mm	Total width mm	TPE tyres mm	Pneumatic tyres mm	Net weight kg
Stairway trucks	TK1325	200	1300	250	320	590	160 x 40	-	18
	TK1326	200	1300	300	480	590	160 x 40	-	22
	TK1327	200	1300	250	320	590	-	260 x 85	20
	TK1328	200	1300	300	480	590	-	260 x 85	22
Wheel spider lock	1770	for TK1325 and TK1326							
Handle	1762	with safety loop for tube-Ø 27 mm							



AK1325



AK1326



AK1327



AK1328



Three-arm wheel spider
AK1325 | AK1326



Five-arm wheel spider
AK1327 | AK1328



Wheel spider lock 1770
Add-on kit for stairway trucks
AK1325 and AK1326. For easy
moving on 2 wheels on flat
surface. Easy self assembly.



Wheel-fixing
screwed wheel fixing, easy
wheel change.

Aluminium stairway trucks

Aluminium tube with aluminium blades, handy welded construction. Safety handles. Aluminium sheet shovel mountable. Flat packed delivery. Curved top bar and transversal struts. For safe transport of circular items such as rolls, cans, buckets etc.

AK1325 | AK1326

With 2 three-armed wheel spiders, each equipped with 3 TPE tyres 160 mm Ø, hubs with ball bearings.

AK1327 | AK1328

With 2 pneumatic tyres on synthetic rims, hubs with roller bearings and 2 five-armed wheel spiders, each equipped with 5 TPE wheels 125 mm Ø, hubs with bush bearings.

Three-arm wheel spider

With 2 three-armed wheel spiders, advantageous for frequent use on stairs and acceptable ground conditions on flat surface.

Five-arm wheel spider

With 2 pneumatic tyres and 2 five-armed wheel spiders, advantageous for frequent use on bad ground conditions on flat surface and occasional use on stairs.

	Order no.	Capacity kg	Height mm	Lifting blade depth mm	Lifting blade width mm	Total width mm	TPE tyres mm	Pneumatic tyres mm	Net weight kg
Stairway trucks	AK1325	200	1300	250	320	590	160 x 40	-	14
	AK1326	200	1300	300	480	590	160 x 40	-	15
	AK1327	200	1300	250	320	590	-	260 x 85	15
	AK1328	200	1300	300	480	590	-	260 x 85	16
Wheel spider lock	1770	for AK1325 and AK1326							
Handle	1762	with safety loop for tube-Ø 27 mm							

COMPACT HAND TRUCKS | PARCEL CARTS

One-hand operation:
Ready to use in two steps.

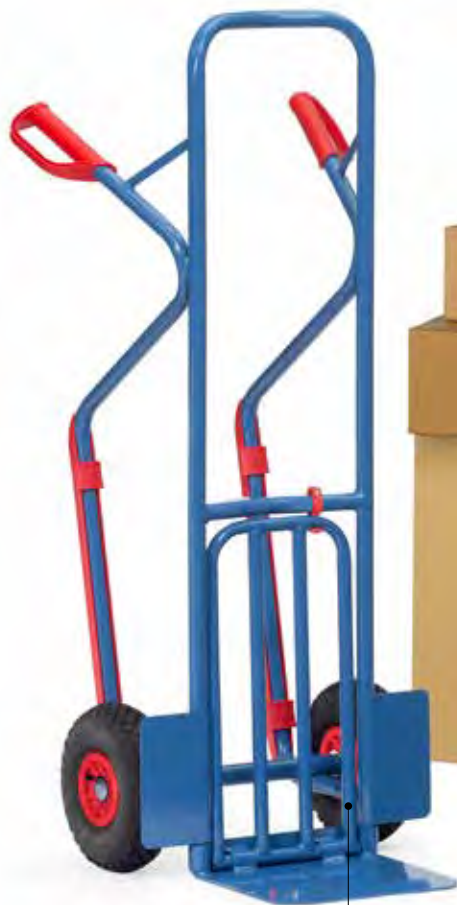

Collapsible blade:
Suitable for large parcels.



Compact hand truck:
Extremely light-weight and handy.



1730



1732



1735



Easy transport



Fast set-up

Compact hand trucks

First-class aluminium-steel tube-construction with aluminium blade and premium plastic parts.

Non-marking blue-grey polymer wheels, hubs with roller bearings.

Hand grip made of comfortable non-slip material.

Integral elasticated retaining straps and strip for safe transportation. Blade and wheels foldable with one move, retractable grip. Ready to use within a few seconds.

1735

Wheels with pneumatic tyres.

Dimensions folded:

Height x Width x Depth (mm)

1730 = 595 x 390 x 50

1732 = 765 x 488 x 64

1735 = 855 x 660 x 135

Dimensions when fully unfolded:

Height x Width x Depth (mm)

1730 = 1030 x 390 x 450

1732 = 1090 x 488 x 490

1735 = 1190 x 660 x 650



	Order no.	Capacity kg	Height mm	Lifting blade depth mm	Lifting blade width mm	Total width mm	Solid rubber tyres mm	Pneumatic tyres mm	Net weight kg
Compact hand trucks	1730	50	1030	300	385	390	127 x 30	-	3,2
	1732	125	1090	320	480	488	170 x 35	-	5,2
	1735	250	1190	450	595	660	-	220 x 70	12,6



Alu-Compact hand truck „Wuppi“

Very handy and shapely universal truck with collapsible blade. Ergonomic handlebars allow grip positions to be adapted to individual body size and various transport situations and protect hands from scratches and bruises. Curved swing arms for easy transport of round goods.

Very robust and perfectly finished aluminium design with aluminium blade and high-quality plastic parts.

Sturdy pneumatic wheels with ball bearings, can be removed in a few easy steps if necessary. Handlebars made of skin-friendly material.

Due to its compact design and the fact that the blade can be collapsed with a single foot movement, the truck is perfectly suited for mobile use, e.g. to be taken along in a delivery vehicle.

Dimensions with collapsed blade:

Height x width x depth (mm):
1250 x 570 x 275

Dimensions with extended blade:

Height x width x depth (mm):
1250 x 570 x 445

Clamping band for load securing 1722G

Two pieced. By flat loops 100 mm long on both ends very easy to fasten in any position at the truck frame.

Tight end 0,3 m with aluminium belt clamp, lose end 2,5 m.

Due to the asymmetric parting suitable for small and large transport goods.

Holding horns for round goods 1722H

Practical holding horns for stabilising of round goods.

In 3 heights each in pairs plugable. 2 positions possibilities for different radii.

1 set = 2 pieces



1722



Example of use



Example of use



Clamping band 1722G



Clamping band 1722G



Holding horns 1722H



Holding horns 1722H

	Order no.	Capacity kg	Height mm	Lifting blade depth mm	Lifting blade width mm	Total width mm	Pneumatic tyres mm	Net weight kg
Compact hand truck	1722	200	1250	165	425	570	225 x 68	6,7
Clamping band	1722G	compatible for all trucks						
Holding horns	1722H	1 set = 2 pieces (only for 1722)						



Parcel carts

Handy tubular steel trucks with big collapsible lifting blade. Steel sheet front shovel mountable, therefore exchangeable. Sturdy welded construction, powder coated, blue RAL 5007. Curved top bar and transversal struts. For safe transport of circular items such as rolls, cans, buckets etc.

Optionally solid rubber, pneumatic tyres or puncture-proof polyurethane tyres on synthetic rims, hubs with roller bearings.

Flat packed delivery.

Utility patent
20 2004 010 071.1

K1116V | K1116L

K1326V | K1326L

K1116V | K1116L

With tubular steel blade, depth 150 mm, width 400 mm, and collapsible lifting blade made of tubular steel, depth 500 mm, width 330 mm.

**K1326V | K1326L
K1331V | K1331L**

With tubular steel blade, depth 250 mm, width 320 mm, and collapsible lifting blade made of tubular steel, depth 500 mm, width 250 mm.

K1331V | K1331L

With replaceable plastic skids.

K1331V | K1331L



Wheel-fixing
screwed wheel fixing, easy wheel change.



Shovel fixation
When not in use the collapsible shovel can be fixed.

Wear parts

Handle 1762

With safety loop for tube-Ø 27 mm. See page 186.

Plastic skids 1753

1 set with clips. See page 186.

	Order no.	Capacity kg	Height mm	Lifting blade depth mm	Lifting blade width mm	Total width mm	Tyre size mm	Tyres	Net weight kg
Parcel carts	K1116V	250	1150	150/500	400/330	620	260 x 56	solid rubber	17,5
	K1116L	250	1150	150/500	400/330	620	260 x 85	pneumatic	14,5
	K1116P	250	1150	150/500	400/330	620	260 x 85	polyurethane	15,2
	K1326V	300	1300	250/500	320/250	580	260 x 56	solid rubber	19,5
	K1326L	300	1300	250/500	320/250	580	260 x 85	pneumatic	16,5
	K1326P	300	1300	250/500	320/250	580	260 x 85	polyurethane	17,2
	K1331V	300	1300	250/500	320/250	580	260 x 56	solid rubber	19,5
	K1331L	300	1300	250/500	320/250	580	260 x 85	pneumatic	16,5
	K1331P	300	1300	250/500	320/250	580	260 x 85	polyurethane	17,2

Accessories on page 186



Chair trucks
B1335V | B1335L |
B1335P

For transporting stacked chairs.
 Of tubular construction.
 A combination of stacking trolley B1325V | B1325L with chair carrying facility.

Sturdy welded construction, powder coated blue RAL 5007 only. Optionally solid rubber, pneumatic tyres or puncture-proof polyurethane tyres on synthetic rims, hubs with roller bearings

Curved top bar and transversal struts. For safe transport of circular items such as rolls, cans, buckets etc.

The carrying arms are engaged to the trolley and can be continuously adjusted in height.

The carrying arms are covered with protective hoses.

When not in use as a chair trolley the arms will fold back to the main frame so that the trolley can be used for other purposes (as picture).

Carrier arms:

- Depth 500 mm
- Width 250 mm
- Capacity 70 kg

German patent
 10 2004 034 195

B1345V | B1345L |
B1345P

As B1335V | B1335L | B1335P, but carrier spar can be screwed with clamp to truck.

After loosen the 2 screws the carrier spar can be continuously adjusted in height.

The carrying arms are covered with protective hoses.

Carrier arms:

- Depth 500 mm
- Width 320 mm
- Capacity 70 kg



B1335L Carrying spar hooked up

Carrying arms put in resting position.



B1345L Carrying spar screwed with truck



Solid rubber tyres



Pneumatic-tyres



PU-tyres

	Order no.	Capacity kg	Height mm	Lifting blade depth mm	Lifting blade width mm	Total width mm	Tyre size mm	Tyres	Net weight kg
Chair trucks	B1335V	300	1300	250	320	580	260 x 56	solid rubber	19
	B1335L	300	1300	250	320	580	260 x 85	pneumatic	16
	B1335P	300	1300	250	320	580	260 x 85	polyurethane	16,7
	B1345V	300	1300	250	320	580	260 x 56	solid rubber	19
	B1345L	300	1300	250	320	580	260 x 85	pneumatic	16
	B1345P	300	1300	250	320	580	260 x 85	polyurethane	16,7



Example application



11040



11042



Carrier spars 11045 or transport on stairs with 11030 | 11040 | 11042



Clamping band

Trucks for appliances

11040

Truck for transporting appliances, such as stoves, refrigerators, washing machines and dish washers, etc. Sturdy welded tubular steel construction, powder coated in blue RAL 5007. Wide rubber pads and non-slip cover on the blades. Pneumatic tyres. Wheel hubs with roller bearings.

11042

As 11040, but with larger frame height and effective height. Therefore it is possible to transport 2 machines on top of each other.

Accessories

Carrier spars

11045

2 handholds with clamps and wide cross strut, welded, powder coated blue RAL 5007.

Clamping band

11047

For securing the transport goods.

Length 3,30 m, width 25 mm, with quick release fastener.



	Order no.	Capacity kg	Height mm	Lifting blade depth mm	Lifting blade width mm	Total width mm	Pneumatic tyres mm	Net weight kg
Trucks for appliances	11040	350	1150	150	450	650	260 x 85	15
	11042	350	1425	150	450	650	260 x 85	18
Carrier spars	11045	350	850	-	-	570	-	3,2
Clamping band	11047	-	-	-	-	-	-	-

DRUM- | STEEL BOTTLE TROLLEYS

Support wheels:

Makes transport easier and helps when placing the drums on pallets or drain pan.



Great variety:

There is a suitable model for all bottle sizes and applications.



Safety:

Secure hold of the bottles due to hookable safety chain and rims on three sides of the shovels.

Drum dollies

Welded steel construction, powder coated, blue RAL 5007. 4 castor rollers, 2 with wheel lock. Wheels made of polyamide. Hubs with glide bearing. Wheel size 80 x 35 mm.

1360

Drum dolly for upright transport of 60 and 200 litres steel drums.

Welded flat steel construction. Cross struts bent down at right angles Ø 420 mm for 60 litres steel drums. Interior of outer race Ø 610 mm for 200 litres steel drums.



1360



1361

1361

Drum dolly for upright transport of 200 litres steel drums. With closed sheet steel save-pan, oil-proof welded. Interior-Ø 630 mm, rim 80 mm high.



13600



13610

13600

As 1360, but with handle screw-on type, with 2 eyelets and 1 clamping band.

13610

As 1361, handle screw-on type, with 2 eyelets and 1 clamping band.

13650

Drum dolly for upright transport or storage of 200 litre steel drums.

Welded cross made of square pipe, with anti-slip corners, powder coated blue RAL 5007.



13650

	Order no.	Capacity kg	Wheel-Ø mm	Total height mm	Net weight kg
Drum dollies	1360	250	80 x 35	154	12
	1361	250	80 x 35	179	15
	13600	250	80 x 35	914	16
	13610	250	80 x 35	894	17
	13650	250	80 x 35	159	6



**Drum trolleys
1065 | 1066**

Drum trolleys, welded tubular steel, powder coated, RAL blue 5007, durable surface protection.

Wheels either with solid rubber tyres 250 x 60 mm or pneumatic tyres 260 x 85 mm, hubs with roller bearings.

Suitable for all rimmed 200 litre drums.

Height: 1600 mm

Width: 680 mm

1071 | 1072

As for 1066, but with an additional supporting castor wheel made of TPE 200 x 40 mm.

2078 | 2079

As for 1066, but with 2 additional supporting castor wheels made of solid rubber blue-grey, 160 x 40 mm.

With this version, filled barrels can easily be loaded and unloaded from pallets.

2080 | 2081

Drum trolley for 120-220-litre plastic drums, welded tubular steel, blue RAL 5007, surface durably protected.

Wheels with solid rubber tyres 250 x 60 mm or pneumatic tyres 260 x 85 mm, hubs with roller bearings.

Tension belt to secure the drums.

Height: 1300 mm

Width: 640 mm

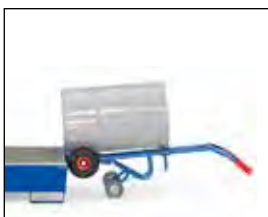

Parking a drum on drain pan.

Trolley with drum in filling position.



	Order no.	Capacity kg	Tyres	Net weight kg	
Drum trolleys	1065	300	Solid rubber	16	
	1066	300	Pneumatic	14	
	1071	300	Solid rubber	22	
	1072	300	Pneumatic	20	
	2078	300	Solid rubber	23	
	2079	300	Pneumatic	21	
	2080	250	Solid rubber	20	
	2081	250	Pneumatic	18	



Mobile drum cradles

For transporting, storing and draining of 200-litre drums. Tubular steel construction, bolted, powder coated blue RAL 5007. Tension belt to secure the drums. Flat packed for easy self assembly.

2015

mobile drum cradle with lever handle, mobile. With rollers for turning the drums. Applying the drums without lever handle, as shown in application below.

2 polyamide swivel castors 125 x 38 mm and 2 polyamide wheels 150 x 40 mm. Swivel castors with wheel locks.

2016

As 2015, but with 2 steel rolls 50 mm Ø and 500 mm long.

For easy turning of drums. Particularly suitable for thin walled drums.



2015



2016



Application



Oil drain pan 2019

As add-on kit for drum cradle 2015 and 2016, extricable. Plastic oil drain pan 12 litres content.



Lever handle 2020

Delivery without lever handle possible (application of multiple drum cradles). Please indicate when ordering: e.g. „2015-2020“



	Order no.	Capacity kg	Outside dimensions L x W x H mm	Net weight kg
Mobile drum cradles with lever handle	2015	250	900 x 615 x 600	21
	2016	250	900 x 615 x 600	24
Oil drain pan	2019	-	-	3,4
Lever handle (separate)	2020	-	-	4,2



**Drum trolley
2702 | 2703**

Welded steel construction, oil pan 100 mm high, oil-tight, powder coated blue RAL 5007. Grid flush inserted, mesh size 31 x 31 mm, hot-dip galvanized. 2 swivel and 2 fixed-wheel castors 125 x 38 mm, made of polyamide, hubs with roller bearings.

Swivel castors with wheel locks.

For transporting one or two 200-litres drums. Prevents damage in the event of oil leakage. Drain pan 45/54 litres.

**Table top cart
2722**

Top steel tray 100 mm high, oil-tight. Base with conical drain and drain tap 1/2".

Grid with mesh width of 31 x 31 mm, loosely inserted, flush at the top hot-dip galvanized. Lower steel plate tray 25 mm high, oil-tight.

2 swivel and 2 fixed-wheel castors, TPE tyres, hubs with groove ball bearing. Swivel castors with locks.

Shelf heights: 181/901 mm
Capacity upper shelf: 100 kg



**Waste collectors
1385 | 1386**

Waste collectors in tubular steel design, powder coated, RAL 7035 grey. PVC lid and clamping ring, aperture Ø 340 mm.

Suitable for 120 litre rubbish bags.

1385 = 4 support legs

1386 = 2 support legs and 2 wheels with solid rubber tyres 150 mm Ø

Flat packed for easy self assembly.



**Waste collector
1397**

Waste collector with clamp for tube-Ø 27 mm. Powder coated blue RAL 5007. PVC lid and clamping ring, aperture Ø 340 mm. Suitable for 120 litre rubbish bags.

*Can not be fitted with FIXSTOP.

	Order no.	Capacity kg	Wheel-Ø mm	Platform size L x W mm	Outside dimensions L x W x H mm	Net weight kg
Drum trolley	2702*	400	125	1000 x 600	1130 x 611 x 990	37
	2703*	600	125	1250 x 650	1380 x 661 x 990	55
Table top cart	2722	300	125	1000 x 600	1136 x 611 x 1030	52

	Order no.	Height mm	Width mm	Depth mm	Net weight kg
Waste collectors	1385	960	500	500	5
	1386	960	500	500	9
	1397	333	574	376	4



Steel bottle trolleys

Welded and powder coated blue RAL 5007, tubular steel design. Bottle support with safety chain. Wheels optionally with solid rubber or pneumatic tyres, hubs with roller bearings.

51005

For 2 bottles, each 10 litres contents, Ø 140 mm. Wheels only with TPE tyres 200 x 40 mm.

51006 | 51007

For 2 bottles, each 20 litres contents, Ø 204 mm.

51011 | 51012

For 2 bottles, each 40-50 litres contents, Ø 204-229 mm. Receptacle for welding wire.

51021 | 51022

As 51011 | 51012, but with 1 additional supporting castor wheel, TPE tyre 200 x 40 mm.

Tool box

51060

Powder coated RAL 7035 grey

Size L x W x H:

450 x 200 x 150 mm

Lockable with padlock (not included in delivery).

Suitable for:

51006 | 51007

51011 | 51012



Tool box 51060



51005



51006 | 51007



51011 | 51012



51021 | 51022

	Order no.	Capacity kg	Height mm	Total width mm	No. of bottles x size in litres or kg	Solid rubber tyres mm	Pneumatic tyres mm	Net weight kg
Steel bottle trolleys	51005	50	1000	505	2 x 10	-	-	7,5
	51006	100	1100	760	2 x 20	260 x 56	-	19,5
	51007	100	1100	760	2 x 20	-	260 x 85	17
	51011	150	1300	830	2 x 40 - 50	400 x 74	-	28
	51012	150	1300	830	2 x 40 - 50	-	400 x 100	18
	51021	150	1300	830	2 x 40 - 50	400 x 74	-	35
	51022	150	1300	830	2 x 40 - 50	-	400 x 100	25
Tool box	51060	-	-	-	-	-	-	5



Steel bottle trolleys

Welded and powder coated blue RAL 5007, tubular steel design.

Bottle support with chain.

Wheels optionally with solid rubber or pneumatic tyres, hubs with roller bearings.

51091 | 51092

For 1 steel bottle 10 litres content, Ø 140 mm.

51101 | 51102

For 1 steel bottle 20, 40 or 50 litres contents, Ø 204-229 mm.

51121 | 51122

with screwable bottle support for 1 propane gas bottle 33 kg content, Ø 318 mm or for 1 propane gas bottle 11 kg content, Ø 300 mm.

	Order no.	Capacity kg	Height mm	Total width mm	No. of bottles x size in litres or kg	Solid rubber tyres mm	Pneumatic tyres mm	Net weight kg
Steel bottle trolleys	51091	100	1240	420	1 x 10	260 x 56	-	11
	51092	100	1240	430	1 x 10	-	260 x 85	9
	51101	100	1240	500	1 x 20 - 50	260 x 56	-	11
	51102	100	1240	510	1 x 20 - 50	-	260 x 85	8,5
	51121	100	1240	550	1 x 11 / 1 x 33	260 x 56	-	14,5
	51122	100	1240	560	1 x 11 / 1 x 33	-	260 x 85	12



Steel bottle stairway truck 51325

For transport on stairs.
 For 1 steel bottle of 20, 40 and 50 litres contents or 1 propane gas bottle 11 and 33 kg.
 Stairway truck TK 1325 is the basis product, additionally equipped with 4 perforated wide cross struts to screw bottle support with safety chain.
 With 2 three-armed wheel spiders, each equipped with 3 TPE tyres 160 mm Ø.
 Tubular steel, powder coated, blue RAL 5007.

Steel bottle dolly 51160

Steel bottle dolly for 1 propane gas bottle 11 kg contents, Ø 300 mm. Welded steel construction, powder coated blue RAL 5007. Interior-Ø 310 mm. 4 castor wheels, 2 with wheel locks. TPE tyres 75 x 25 mm, hubs with ball bearings.

51161

as 51160, but additionally with a clamp for winding up hose and a holder for shrink wrapping pistols.

51162

as 51161, but additionally with a holder for commercially available preheating and flame burners.



Example of use 51161



Example of use 51162

	Order no.	Capacity kg	Height mm	Total width mm	No. of bottles x size in litres or kg	TPE tyres mm	Net weight kg
Steel bottle stairway truck	51325	200	1300	590	1 x 20 – 50	160 x 40	22
Steel bottle dollies	51160	80	970	410	1 x 11	75 x 25	7
	51161	80	970	410	1 x 11	75 x 25	9,7
	51162	80	970	410	1 x 11	75 x 25	10



51150



51114 | 51123 | 51132

**Steel bottle stand
51150**

Stand for 2 bottles, each 40-50 litres contents, Ø 204-229 mm. Steel section/ steel sheet design, powder coated. Secured with chain. Pre-drilled for connecting or for wall fixing.

**Wall mounting
51114 - 51332**

Wall mounting for 1-3 steel bottles, bottle-Ø 140, 230 and 320 mm. Steel sheet construction, pre-drilled U-shaped rail for wall fixing, 1-3 bottle clamps, secured with chain, hot-dip galvanized.



51214 | 51223 | 51232



51314 | 51323 | 51332

	Order no.	Capacity kg	Height mm	Total width mm	No. of bottles	Bottles-Ø mm	Net weight kg
Steel bottle stand	51150	100	1000	550	2	204-229	15
Wall mounting	51114	-	45	210	1	140	0,8
	51123	-	45	300	1	230	1,0
	51132	-	45	390	1	320	1,3
	51214	-	45	420	2	140	1,6
	51223	-	45	600	2	230	2,1
	51232	-	45	780	2	320	2,3
	51314	-	45	630	3	140	1,9
	51323	-	45	900	3	230	3,2
	51332	-	45	1170	3	320	4,1

TYRE TRANSPORT EQUIPMENT

Simple handling:

Spreading carrier spars can be operated by pressing the handle levers together. Easy movement of wheel or tyre stacks.



Smart solution:

TYRE TROLLEY with hardware skip for wheel and tyre stacks.

Combine with:

The TYRE TROLLEY including its load can be picked up by the tyre truck.



4546



4547



Example of use



Stackable



Hardware skip

„TYRE TROLLEY“ 4546

Smart dolly for easy transport and effective storage of normal-sized wheels and tyres. Designed for 8 tyres or 4 complete wheel sets. Practical hardware skip for storing small parts. Allows for easy and secure stacking. Compatible with the fetra tyre trucks 2032 and 2033. Platform made of fibreglass-reinforced polypropylene, 4 swivel castors with TPE tyres, one with lockable brake. Scaled pricing for 1/2/6 units.

„TYRE TROLLEY“ 4547

Transport dolly for large wheels and tyres as they are used e.g. for SUVs. Castors with larger wheels facilitate transport on uneven surfaces. Designed for 8 tyres or 4 complete wheel sets. Practical hardware skip for storing small parts. Allows for easy and secure stacking. Compatible with the fetra tyre trucks 2032 and 2033. Platform made of fibreglass-reinforced polypropylene, 4 swivel castors with solid rubber tyres, one with lockable brake. Scaled pricing for 1/2/4 units.

	Order no.	Capacity kg	Wheel-Ø mm	Diameter mm	Height mm	Net weight kg				
„TYRE TROLLEY“	4546	120	75	630	110	3,7				
	4547	180	100	700	140	6,3				



Tyre trucks
2032 | 2033

Welded tubular steel, powder coated blue RAL 5007, surface durably protected.

Wheels optionally with solid rubber or pneumatic tyres. Hubs with roller bearings.

By activating the hand grips, the truck spreads its carrier spars (made of tubular steel) so that the stack of tyres can be taken up and down directly. Suitable for tyres-Ø 450 to 750 mm. Up to 8 wheels and tyres possible.

Compatible with „TYRE TROLLEY“ 4546 and 4547.



2033 | 2033A



2032A | 2033A

as 2032 | 2033, but with pick-up rolls. Smoother picking up and putting down of wheel or tyre stacks. The carrier spars roll along the stack. Therefore significant reduced exertion of force for the user. Retrofittable for all fetra tyre trucks.

2034 | 2035

as 2032 | 2033, but for larger wheels and tyres like e.g. of SUVs. Suitable for tyres from 450 up to 860 mm Ø.

2034A | 2035A

as 2034 | 2035, but with pick-up rolls. Smoother picking up and putting down of wheel or tyre stacks. The carrier spars roll along the stack. Therefore significant reduced exertion of force for the user. Retrofittable for all fetra tyre trucks.



2035 | 2035A



Pick-up roll

	Order no.	Capacity kg	Height mm	Lifting blade length mm	Lifting blade width mm	Total width mm	Solid rubber tyres mm	Pneumatic tyres mm	Net weight kg
Tyre trucks	2032	200	1510	575	500 – 885	730	250 x 60	–	27,5
	2033	200	1510	575	500 – 885	730	–	260 x 85	24,5
	2032A	200	1510	575	500 – 885	730	250 x 60	–	28
	2033A	200	1510	575	500 – 885	730	–	260 x 85	25
	2034	200	1510	660	500 – 945	730	250 x 60	–	28,5
	2035	200	1510	660	500 – 945	730	–	260 x 85	25,5
	2034A	200	1510	660	500 – 945	730	250 x 60	–	29
	2035A	200	1510	660	500 – 945	730	–	260 x 85	26
	Pick-up rolls	E2034A							

Add-on kit for existing tyre trucks



4586



4596



4588



4562



Roller conveyor



Extended platform



Steps tilted

Tyre trolleys

Tubular steel and steel section construction, powder coated blue RAL 5007.

4586

Tyre carrier variable adjustable in intervals of 150 mm with clamps on the face ends.

For tyre diameter 250 - 750 mm.

4 swivel castors, TPE tyres, hubs with groove ball bearing. Swivel castors with wheel lock.

4596

Shelves with welded wire lattice 140 x 40 mm.

Carriers variably insertable within a distance of 120 mm. Due to the joint-like attachment, the carriers adapt automatically to the tyre size.

For tyre diameter 380 - 750 mm.

2 swivel and 2 fixed-wheel castors, TPE tyres, hubs with groove ball bearing. Swivel castors with wheel locks.

4588

As 4586, but reinforced version for heavy duty, e.g. for motor-sports as tyre trolley in pit lane.

For tyre diameter 400 - 780 mm.

4 swivel castors with blue-grey elastic tyres, hubs with ball bearing. 2 wheels with locks.

4562

For comfortable order picking of wheels and tyres. Tyre carrier with robust roller conveyors with fall through protection for easy moving of loaded wheels and tyres with 550 - 850 mm Ø.

Upper shelf screwable in height of 1.253 or 1.153 mm, capacity 80 kg.

At face ends 4 wooden steps lifting automatically when released and locking the trolley via rubber feet when under load. Safety stand on upper step by extended platform.

Safety handle to hold onto or lean against. The steps can be completely tilted assisted by a gas spring.

4 swivel castors, TPE tyres, hubs with groove ball bearing. Swivel castors with wheel lock.

	Order no.	Capacity kg	Wheel-Ø mm	Platform size L x W mm	Outside dimensions L x W x H mm	Net weight kg
Tyre trolleys	4586	250	160	1420 x 600	1540 x 670 x 1725	40
	4596	400	200	1420 x 610	1600 x 620 x 1800	62
	4588	500	200	1860 x 618	1991 x 671 x 1671	62
Tyre trolleys	4562	250	125	1000 x 588	1343 x 625 x 1749	63

Accessories on page 184-185

LIFTING EQUIPMENT



Reliable:
High-quality hydraulics for a long service life.

Up high:
Double shears for a particularly large lifting range.



Versatile:
Hand stacker for occasional use.



2117

Pallet trucks

Frames and forks of steel construction, finished powder coated distinct yellow. Hand hydraulic pump with maintenance-free bearing. Strong steel handle with counter bearing for pushing operation. Powder coated black; operating lever for: lifting, moving, lowering. Steering lock 2 x 100° Fork length 1150 mm Fork width 160 mm Loading width 540 mm Lifting range 85-200 mm Overall length 1540 mm Steering wheels 200 x 50 mm Fork rollers 80 x 70 mm Locating wheels at fork tips.



2114



2115

2114

Handle powder coated. Loading width: 540 mm Fork rollers Ø x W = 80 x 93 mm

Wheels 2114

Steering wheels polyurethane, fork rollers polyurethane single. Low rolling resistance, non-marking.

Wheels 2115

Steering nylon, fork rollers tandem nylon. Very little rolling resistance. High chemical resistance, non-marking. Good on even, smooth surfaces. Hard road noise.



2116



2119

Wheels 2116

Steering elastic-solid rubber wheels, nylon tandem rollers. Low rolling resistance. Easy movement. Good on level and uneven surfaces or when negotiating edges and bumps. Low road noise.

Wheels 2117

Steering wheels polyurethane. Fork rollers tandem polyurethane. Low rolling resistance. Easy movement. Good on sensitive surfaces. Non-marking. Low road noise.

Wheels 2119

Steering wheels with elastic solid rubber tyres. Fork rollers tandem polyurethane. Low rolling resistance. Easy movement. Comfortable to operate. Good on sensitive and uneven surfaces. Advantageous when frequently going over edges and bumps. Low road noise.

Warranty

for pallet trucks 2 years.



Handle
rubber coated.



Tandem rollers
Two adjustable rollers housed in each fork. Advantageous for uneven surfaces and when going over edges and bumps. Locating wheels at fork tips.

	Oder no.	Capacity kg	Lifting range mm	Fork length mm	Steered wheels	Fork rollers	Net weight kg
Pallet trucks	2114	2000	85 – 200	1150	Polyurethane	Polyurethane single	60
	2115	2500	85 – 200	1150	Nylon	Nylon Tandem	73
	2116	2500	85 – 200	1150	Solid rubber	Nylon Tandem	75
	2117	2500	85 – 200	1150	Polyurethane	Polyurethane Tandem	76
	2119	2500	85 – 200	1150	Solid rubber	Polyurethane Tandem	75

Pallet trucks

Frames and forks of steel construction, finished powder coated distinct yellow. Hand hydraulic pump with maintenance-free bearing. Strong steel handle with counter bearing for pushing operation. Powder coated black; operating lever for: lifting, moving, lowering.

2118

Short type

Fork length 800 mm
Total length 1190 mm
extremely space saving and suitable for HGVs.

2120

Low type

Lowered height 55 mm
Lifting range 55-175 mm, suitable for underclearances from 57 mm.
Steered wheels:
Ø x W = 180 x 50 mm
Fork rollers:
Ø x W = 51 x 70 mm

2116-15 | 2116-18 | 2116-20

Extra long model.

Fork lengths 1500, 1800 or 2000 mm. Steering wheels 200 x 50 mm solid rubber tyres. Fork rollers 80 x 70 mm nylon tandem. Reduced lifting capacity.

2122

with scale

Pallet truck with scale, weighing range of 1- 2000 kg, with a weighing accuracy of ± 2 kg. Graduation: 1 kg. LCD-display with 18 mm high figures, touch-panel with on-/ off- and tare weight button. Power supply by 4 x 1,5-V-AA-batteries, protection class IP 65. Steering wheels Ø x W = 180 x 50 mm
Fork rollers Ø x W = 70 x 70 mm
Loading width 550 mm



2118



2120



2116-15 | 2116-18 | 2116-20



2122



Pallet truck with scale

Warranty

for pallet trucks 2 years.

	Order no.	Capacity kg	Lifting range mm	Fork length mm	Total length mm	Steered wheels	Fork rollers	Net weight kg	
Pallet trucks	2118	2500	85 – 200	800	1190	Solid rubbers	Nylon Single	66	
	2120	2000	55 – 175	1150	1540	Solid rubbers	Nylon Tandem	72	
	2116-15	1500	85 – 200	1500	1890	Solid rubbers	Nylon Tandem	97	
	2116-18	1200	85 – 200	1800	2190	Solid rubbers	Nylon Tandem	100	
	2116-20	1000	85 – 200	2000	2390	Solid rubbers	Nylon Tandem	112	
	2122	2000	85 – 205	1150	1550	Polyurethane	Polyurethane Tandem	117	



6815



6820



6821



Attachable platform
for skid lifter
6820 and 6821.

**High lift pallet truck
6815**

Frame and forks made in non-buckling shell-type construction, powder coated, signal yellow. Hydraulic hand pump, service-free bearing. Sturdy tubular steel drawbar with counter bearing for shove operation, powder coated, black, rubber covered handle. Operating lever for the following functions:

- Lifting - moving - lowering
 - Steering lock: 2 x 100°
 - Carrying capacity: 1000 kg
 - Fork length: 1165 mm
 - Fork width: 160 mm
 - Carrying width: 540 mm
 - Lifting range: 85-800 mm
 - Total length: 1540 mm
 - Steered wheels: Ø x W = 180 x 50 mm
 - Fork rollers: Ø x W = 80 x 50 mm
 - Climbing rolls at fork tips.
- High lift pallet truck is no longer movable from pumping height of 290 mm.

Skid lifter 6820

Excellent stability under load and travelling even with lifted load. Frame and forks made in sectional steel construction, powder coated anthracite RAL 7016. Sturdy tubular push handle. Hydraulic pump with chromium-plated piston and overload valve. Operated via pedal control. Lowering valve to be operated via hand lever. 2 castor wheels with polyurethane tyres 150 x 40 mm and 2 fork rollers nylon 70 x 70 mm, castor wheels with lock.

- Carrying capacity: 500 and 1000 kg
- Fork length: 1115 mm
- Fork width: 153 mm
- Carrying width: 526 mm
- Lifting range: 85 - 830 mm
- Total length: 1550/1640 mm
- Total width: 526/687 mm

Skid lifter 6821

Construction as above, but additionally with equipped with a steering shaft.

Attachable platform

Made of edged steel plate powder coated anthracite RAL 7016, suitable for 6820 and 6821.

Measures (L x W): 1115 x 538 mm

Warranty

for high lift pallet truck and skid lifter 2 years.

	Order no.	Capacity kg	Lifting range mm	Fork length mm	Steered wheels	Fork rollers	Net weight kg
High lift pallet truck	6815	1000	85 – 800	1165	Polyurethane	Polyurethane	110
Skid lifter	6820	500	85 – 830	1115	Polyurethane	Nylon	107
	6821	1000	85 – 830	1115	Polyurethane	Nylon	135
Attachable platform	6828	–	–	–	–	–	15

Stackers

For the occasional use as lifting and transport appliance. Sturdy sectional steel construction with tubular push handles, powder coated anthracite grey RAL 7016.

Hand winch stacker

6851 | 6852

Lifting by means of safety hand winch. Forks adjustable.

2 castor wheels, wheels with polyurethane tyres 150 x 40 mm and 2 fork rollers nylon 80 x 47 mm. Castor wheels with lock.

Load center distance:
400/500 mm

Fork width 6851: 75 mm

Fork width 6852: 80 mm

Stroke per crank turning:
40/22 mm

Hydraulic hand stackers

6855 | 6856

Hydraulic pump with chromium-plated piston and overload valve. Operated via drawing shaft.

Lowering valve precisely adjustable via hand lever.

2 castor wheels, wheels with polyurethane tyres 150 x 40 mm and 2 fork rollers polyurethane 80 x 70 mm. Castor wheels with lock.

Load center distance: 585 mm

Fork width: 160 mm

Stroke per shaft operation:
20/12.5 mm



6851 | 6852



6855 | 6856

	Order no.	Capacity kg	Lifting range mm	Total height mm	Fork length mm	Carrying width mm	Total length mm	Total width mm	Net weight kg
Hand winch stacker	6851	250	90 – 1560	2030	800	170 – 690	1350	725	140
	6852	500	90 – 1560	2030	1000	170 – 690	1550	725	146
Hydraulic hand stacker	6855	500	88 – 1500	2010	1150	540	1600	794	210
	6856	1000	88 – 1500	2010	1150	540	1600	794	220

Warranty

for stackers 2 years.

Lifting table carts

Sectional steel/steel plate construction, powder coated anthracite grey RAL 7016. Sturdy tubular push handle. Hydraulic pump with chromium-plated piston. Operation via pedal control. Lowering valve precisely adjustable via hand lever. Platform 50 mm high. 2 castor and 2 fixed wheels, wheels with polyurethane tyres, castor wheels with lock.



6831



6832



6833 | 6834 | 6835



6836 | 6837 | 6838

6831

Tilttable tubular push handle.

6832

Tubular push handle fixed with screws.

6833 | 6834 | 6835

Tubular push handle fixed with screws.

6836 | 6837 | 6838

Double shears for enlarged lifting range. Tubular push handle fixed with screws.

Accessories

For platform size 1010 x 520 mm: (6833/6834/6835/6836/6837)

Roller conveyor 6890

Sectional steel frame with holding angles and 2 upward tilting stops, powder coated anthracite RAL 7016. 9 steel rolls (Ø 57 mm and length 430 mm) with roller bearings.

Distance between axles 112,5 mm, height 64 mm, carrying capacity 500 kg – rigid –

Roller conveyor 6891

Can be fixed to platform with clamped joint, swivelling by 360°, arrestable.

6 steel rolls (Ø 57 mm and length 430 mm) with roller bearings. Distance between axles: 110 mm Height: 92 mm Carrying capacity 500 kg – swivelling –



Roller conveyor with attachable frame.



Roller conveyor with live ring.

	Order no.	Capacity kg	Lifting range mm	Platform L x W mm	Outside dimensions L x W mm	Wheel-Ø mm	Net weight kg
Lifting table carts	6831	150	265 – 755	700 x 450	930 x 450	100	41
	6832	250	330 – 910	830 x 500	1020 x 500	125	78
	6833	500	435 – 1000	1010 x 520	1275 x 520	150	118
	6834	750	442 – 1000	1010 x 520	1275 x 520	150	120
	6835	1000	445 – 950	1010 x 520	1275 x 520	150	137
	6836	300	435 – 1585	1010 x 520	1275 x 520	150	150
	6837	500	440 – 1575	1010 x 520	1275 x 520	150	168
	6838	1000	520 – 2000	1200 x 800	1430 x 800	200	242
Roller conveyor with attachable frame	6890	500	–	–	–	–	31
Roller conveyor with live ring	6891	500	–	–	–	–	51

Warranty

for lifting table carts 2 years.

Machine lifter
6931/6932

Hydraulic, for lifting of machines and other heavy loads. Easy lifting with lifting claw and end plate by means of installed hydraulic hand pump. Precise lowering via lowering valve, overload valve. Pump lever detachable. Swivelling of housing by 360°, variable range of application. Sturdy compact steel construction, coating blue RAL 5007.

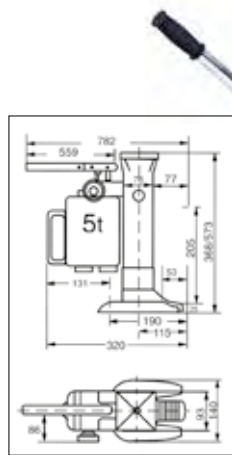

6931

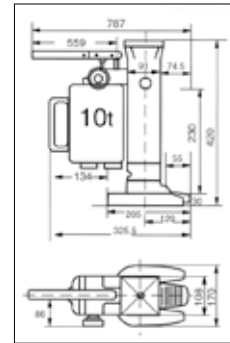

6932

Transport roller
6943 | 6944 | 6945

For the easy and safe transport of heavy goods such as containers, boxes, machines etc. Sturdy welded steel construction with handles made of round or tubular steel, powder coated blue RAL 5007. Carrying platforms with anti-slip rubber cover. Big nylon rolls with roller bearings. High carrying capacity combined with low net weight.



6943



6944



6945

	Order no.	Carrying capacity to	Lifting range at lifting claw mm	Lifting range at end plate mm	Net weight kg
Machine lifters	6931	5	25 – 230	368 – 573	25
	6932	10	30 – 260	420 – 650	35

	Order no.	Carrying capacity kg	Carrying platform L x W mm	Outside dimensions L x W x H mm	Axles	Rolls	Size of rolls Ø x W mm	Net weight kg
Transport rollers	6943	2500	210 x 100	275 x 120 x 100	2	2	85 x 90	4
	6944	3000	330 x 220	400 x 228 x 100	2	4	85 x 85	9,5
	6945	6000	260 x 200	415 x 210 x 100	3	6	85 x 85	12

Warranty
for machine lifters and transport rollers 2 years.

**Moving gear, adjustable
6951 | 6952**

for the easy and safe transport of machines and other heavy goods. Sturdy welded steel construction with handles made of round steel, powder coated blue RAL 5007. Carrying platforms with anti-slip rubber cover. Big nylon rolls with roller bearings.

6953

As 6951/6952, but with big steel wheels with ball bearings.

Adjustable range:

- 6951 = 500–1190 mm
- 6952 = 700–1190 mm
- 6953 = 850–1190 mm

Scope of delivery:

- 2 transport rollers and
- 2 connecting rods made of round steel.



6951



6952



6953

	Order no.	Capacity to	Carrying platform L x W mm	Outside dimensions L x W x H mm	Axles	Rolls	Size of rolls Ø x W mm	Net weight kg
Moving gears, adjustable	6951	6	250 x 200	320 x 268 x 110	4	8	85 x 90	30
	6952	12	350 x 200	420 x 268 x 110	4	12	85 x 90	38
	6953	24	425 x 220	495 x 288 x 110	4	16	83 x 85	88

Warranty

for moving gears 2 years.

Moving gear, steerable 6956 | 6957 | 6958

for the easy and safe transport of machines and other heavy goods.

Sturdy welded steel construction, powder coated blue RAL 5007.

Carrying platforms swivelling and with anti-slip rubber cover. With drawing shaft.

Big nylon rolls with roller bearings.

6956

Shaft with handles.

6957

With a traction eye at the shaft.

6958

as 6957, but with big steel wheels with ball bearings.

Scope of delivery:

1 transport roller with swivelling platform and drawing shaft.



6956



6957



6958



Example of use

	Order no.	Capacity to	Carrying platform L x W mm	Outside dimensions L x W x H mm	Axes	Rolls	Size of rolls Ø x W mm	Net weight kg
Moving gears, steerable	6956	3	185 x 150	300 x 200 x 104	2	4	85 x 90	15
	6957	6	400 x 220	640 x 534 x 115	2	8	85 x 90	50
	6958	12	400 x 220	640 x 566 x 115	2	8	83 x 85	66

Warranty

for moving gears 2 years.



Example of use

6980

**Furniture lifting rollers
6980**

Manual crank for one man transport of cupboards, lockers etc.

Steel tubular construction, powder coated blue RAL 5007. Winch with manual crank arm. Crank protected by a C-profile. Adjustable supports with protective covering. Loading surface with anti-slip covering, lowered 10 mm high. Two steering wheels with non-marking polyurethane tyres and non-tracking elasticated solid rubber tyres, hub with roller bearings. One fixed 5 m long strap. Delivered in pairs.



Example of use

6971

**Lifting rolls
6971**

For the transport of heavy cupboards etc., steel plate frame galvanic bright galvalnize. Contact area with rubber cover, wheel with polyurethane tyres.

Outside dimensions
L x W x H:

170 x 126 x 272 mm

Claw L x W: 170 x 44 mm

Claw height:
lowered = 12 mm
lifted max. = 50 mm

Scope of delivery:
2 lifting rolls and 1 lever rod

Handling:

Lift load with lever rod, place claw of the lifting roll underneath the load and finally lift load completely by shifting the control lever by means of the lever rod. Proceed exactly in the same way on the opposite side with the second lifting roll and the load can be moved.



Example of use

6977

**Angle rolls
6977**

For moving furniture or other box-shaped objects. Low loading height, safe transport.

Welded steel plate housing, powder coated anthracite RAL 7016. Loading platform with non-slip covering. 3 TPE castors 50 x 18 mm, hubs with precision deep groove ball bearing

Width: 361 mm

Depth: 177 mm

Height: 87 mm

Loading height: 16 mm

Scope of delivery: 1 set = 4 pieces (in a robust box)

	Order no.	Capacity per set kg	Stroke mm	Outside dimensions L x W x H mm	Platform W x D mm	Wheel size Ø x W mm	Net weight per set kg
Furniture lifting rollers	6980	600	300	600 x 390 x 800	300 x 110	160 x 50	45

	Order no.	Capacity per pc. kg	Capacity per pair kg	Wheel size Ø x W mm	Net weight 4 pcs. kg	Net weight per pair kg
Lifting rolls	6971	-	1000	138 x 28	-	6
Angle rolls	6977	150	-	50 x 18	10	-

Dollies for furniture 2350 | 2352

With platform made of beech plywood, with non-slip coating. 4 swivel castors with polyamide wheels 100 mm Ø.

Packing unit
1 pair = 2 pieces



2350 | 2352



2351 | 2353

2351 | 2353

As 2350 | 2352, but with 4 swivel castors, wheels with solid rubber tyres 100 mm Ø.

Packing unit
1 pair = 2 pieces



2358



2359

2358

Dollies for furniture with platform made of plywood, with non-slip coating. 4 swivel castors, wheels with solid rubber tyres 125 mm Ø, blue-grey "trackless".

2359

Dollies for furniture with platform made of plywood, non-slip. 4 swivel castors with polyamide wheels 125 mm Ø.



70211 | 70217 | 72217G | 72221R | 72221G | 71221

Wheels with solid rubber tyres 70211 - 72221

Black solid rubber tyres on wheel rims of steel sheet or plastic, hubs with roller bearings.



70417



ESD-solid rubber tyre 70417

Black solid rubber tyres on electrically conductive wheel rims of grey plastic, hubs with roller bearings.

	Order no.	Capacity kg	Length mm	Width mm	Height mm	Polyamide tyres mm	Solid rubber tyres mm	Net weight kg per piece
Dollies for furniture	2350	350	600	300	140	100 x 30	-	4,5
	2351	250	600	300	140	-	100 x 38	5
	2352	500	600	350	140	100 x 30	-	5,5
	2353	300	600	350	140	-	100 x 38	6
	2358	500	800	600	175	-	125 x 38	10
	2359	600	800	600	175	125 x 40	-	10

	Order no.	Wheel- Ø x W mm	Wheel rim	Bearing	Length of hub mm	Ø of bore mm	Capacity kg
Wheels with solid rubber tyres	70211	250 x 60	steel sheet red	roller bearing	60 displaced	20	250
	70213	250 x 60	steel sheet red	roller bearing	75 displaced	25	295
	70217	260 x 56	plastic red	roller bearing	75 displaced	25	300
	72217G	260 x 56	plastic grey	roller bearing	75 displaced	25	300
	72221R	400 x 74	plastic red	roller bearing	75 displaced	25	420
	72221G	400 x 74	plastic grey	roller bearing	75 displaced	25	420
	71221	400 x 80	steel sheet red	roller bearing	75	25	350
ESD-solid rubber	70417	260 x 56	plastic grey	roller bearing	75 displaced	25	300



70107 | 72107G | 70111 | 70116



71120 | 71121 | 72120G | 72121R | 72121G | 72125G



70611 | 70607 | 72607G | 72620G | 72621R | 72621G



71505 | 71515 | 71525

Wheels with pneumatic tyres

70107 - 72121

Black wheels with pneumatic tyres on wheel rims of steel sheet or plastic, hubs with roller bearings.

Wheel with pneumatic tyre

72125G

Bluegrey wheel with pneumatic tyre, non marking (trackless), on wheel rim of plastic, hub with roller bearing.

PU tyres

70607 - 72621

Punctureproof polyurethane material wheels on wheel rims of steel sheet or plastic. Driving comfort similar to pneumatic wheels.

Swivel and fixed-wheel castors

71505 - 71525

Casings made of galvanized steel sheet, wheels with black pneumatic tyres on wheel rims of steel sheet, hubs with roller bearings.

	Order no.	Wheel- Ø x W mm	Profile	Wheel rim	Bearing	Length of hub mm	Ø of bore mm	Capacity kg
Wheels with pneumatic tyres	70111	260 x 85	zig-zag 2 PR	steel sheet red	roller bearing	60 displaced	20	200
	70102	260 x 85	zig-zag 2 PR	plastic red	roller bearing	75	25	200
	70107	260 x 85	zig-zag 2 PR	plastic red	roller bearing	75 displaced	25	200
	72107G	260 x 85	zig-zag 4 PR	plastic grey	roller bearing	75 displaced	25	250
	70113	260 x 85	zig-zag 2 PR	steel sheet red	roller bearing	75 displaced	25	200
	70116	300 x 100	zig-zag 4 PR	steel sheet red	roller bearing	75 displaced	25	220
	71120	400 x 100	ribbed 2 PR	steel sheet red	roller bearing	75	25	250
	71121	400 x 100	zig-zag 4 PR	steel sheet red	roller bearing	75	25	350
	72120G	400 x 100	Rille 2 PR	plastic grey	roller bearing	75	25	250
	72121R	400 x 100	Block	plastic red	roller bearing	75	25	420
	72121G	400 x 100	Block	plastic grey	roller bearing	75	25	420
72125G	400 x 100	Block 4 PR	plastic grey	roller bearing	75 displaced	25	420	

	Order no.	Wheel- Ø x W mm	Profile	Wheel rim	Bearing	Length of hub mm	Ø of bore mm	Capacity kg
PU tyres (Polyurethane)	70611	260 x 85	PU zig-zag	steel sheet red	roller bearing	60 displaced	20	150
	70607	260 x 85	PU zig-zag	plastic red	roller bearing	75 displaced	25	150
	72607G	260 x 85	PU zig-zag	plastic grey	roller bearing	75 displaced	25	150
	72620G	400 x 100	PU ribbed	plastic grey	roller bearing	75	25	250
	72621R	400 x 100	PU zig-zag	plastic red	roller bearing	75	25	250
	72621G	400 x 100	PU zig-zag	plastic grey	roller bearing	75	25	250

	Order no.	Size of wheel mm	Effective height mm	Plate size mm	Hole centres mm	Bolt hole mm Ø	Capacity kg
Swivel castor	71505	220 x 70	250	135 x 110	105 x 75/80	11	150
Swivel castor with lock	71515	220 x 70	250	135 x 110	105 x 75/80	11	150
Fixed-wheel castor	71525	220 x 70	250	135 x 110	105 x 75/80	11	150

You can find help for assigning the right wheel for your cart at: www.fetra.de/en/wheel-assignment or scan the QR code:





Swivel castors

71602 | 71603 | 71604

Casings made of steel sheet, galvanized. Wheels with TPE tyres (thermoplastic elastomer). Plastic rims, hubs with ball bearing and thread protection. Very low starting, rolling and swivelling resistance. Wheels non-marking (trackless).



71602 | 71603 | 71604



71452 | 71453 | 71454

Swivel castors with wheel locks "Double stop"

71612 | 71613 | 71614

Casings made of steel sheet, galvanized. Wheels like swivel castors.



71612 | 71613 | 71614



71462 | 71463 | 71464

Fixed-wheel castors

71622 | 71623 | 71624

Casings made of steel sheet, galvanized. Wheels like swivel castors.



71622 | 71623 | 71624



71472 | 71473 | 71474

TPE-ESD- swivel castors

71452 | 71453 | 71454

Wheels electrically conductive (anti-static) with TPE ESD tyres (thermoplastic elastomer).

Hubs with precision deep groove ball bearing

TPE-ESD-swivel castors with wheel locks "Double stop"

71462 | 71463 | 71464

Casings made of steel sheet, galvanized. Wheels like swivel castors.

TPE-ESD-fixed-wheel castors

71472 | 71473 | 71474

Casings made of steel sheet, galvanized. Wheels like swivel castors.

(ESD= Electrostatic Discharge)

	Order no.	Size of wheel mm	Effective height mm	Plate size mm	Hole centres mm	Bolt hole mm Ø	Capacity kg
Swivel castors TPE	71602	125 x 32	165	105 x 80	80/76 x 60	9	135
	71603	160 x 40	196	135 x 110	105 x 75/80	11	200
	71604	200 x 40	237	135 x 110	105 x 75/80	11	250
Swivel castors with locks TPE	71612	125 x 32	165	105 x 80	80/76 x 60	9	135
	71613	160 x 40	196	135 x 110	105 x 75/80	11	200
	71614	200 x 40	237	135 x 110	105 x 75/80	11	250
Fixed-wheel castors TPE	71622	125 x 32	165	105 x 80	80/76 x 60	9	135
	71623	160 x 40	196	135 x 110	105 x 75/80	11	200
	71624	200 x 40	237	135 x 110	105 x 75/80	11	250

	Order no.	Size of wheel mm	Effective height mm	Plate size mm	Hole centres mm	Bolt hole mm Ø	Capacity kg
Swivel castors TPE-ESD	71452	125 x 32	165	105 x 80	80/76 x 60	9	135
	71453	160 x 40	196	135 x 110	105 x 75/80	11	200
	71454	200 x 40	237	135 x 110	105 x 75/80	11	250
Swivel castors with locks TPE-ESD	71462	125 x 32	165	105 x 80	80/76 x 60	9	135
	71463	160 x 40	196	135 x 110	105 x 75/80	11	200
	71464	200 x 40	237	135 x 110	105 x 75/80	11	250
Fixed-wheel castors TPE-ESD	71472	125 x 32	165	105 x 80	80/76 x 60	9	135
	71473	160 x 40	196	135 x 110	105 x 75/80	11	200
	71474	200 x 40	237	135 x 110	105 x 75/80	11	250



71102 | 71103 | 71104



71252 | 71253 | 71254



71112 | 71113 | 71114



71262 | 71263 | 71264



71122 | 71123 | 71124



71272 | 71273 | 71274

Swivel castors
71102 | 71103 | 71104

Casings made of steel sheet, galvanized. Wheels with blue-grey solid rubber tyres, non-marking (trackless), plastic rims, hubs with roller bearings.

Swivel castors with wheel locks „Double stop“
71112 | 71113 | 71114

Casings made of steel sheet, galvanized. Wheels like swivel castors.

Fixed-wheel castors
71122 | 71123 | 71124

Casings made of steel sheet, galvanized. Wheels like swivel castors.

Swivel castors
71252 | 71253 | 71254

Casings made of steel sheet, galvanized. Wheels with elastic tyres, blue-grey, non-marking (trackless). Alu-rims, hubs with ball bearings. Smooth, silent running, long durability.

Swivel castors with wheel locks “Double stop”
71262 | 71263 | 71264

Casings made of steel sheet, galvanized. Wheels like swivel castors.

Fixed-wheel castors
71272 | 71273 | 71274

Casings made of steel sheet, galvanized. Wheels like swivel castors.

	Order no.	Size of wheel mm	Effective height mm	Plate size mm	Hole centres mm	Bolt hole mm Ø	Capacity kg
Swivel castors Solid rubber blue-grey	71102	125 x 38	165	105 x 80	80/76 x 60	9	100
	71103	160 x 40	196	135 x 110	105 x 75/80	11	135
	71104	200 x 50	237	135 x 110	105 x 75/80	11	205
Swivel castors with locks Solid rubber blue-grey	71112	125 x 38	165	105 x 80	80/76 x 60	9	100
	71113	160 x 40	196	135 x 110	105 x 75/80	11	135
	71114	200 x 50	237	135 x 110	105 x 75/80	11	205
Fixed-wheel castors Solid rubber blue-grey	71122	125 x 38	165	105 x 80	80/76 x 60	9	100
	71123	160 x 40	196	135 x 110	105 x 75/80	11	135
	71124	200 x 50	237	135 x 110	105 x 75/80	11	205

	Order no.	Size of wheel mm	Effective height mm	Plate size mm	Hole centres mm	Bolt hole mm Ø	Capacity kg
Swivel castors Elastic solid rubber blue-grey	71252	125 x 40	165	105 x 80	80/76 x 60	9	200
	71253	160 x 50	196	135 x 110	105 x 75/80	11	300
	71254	200 x 50	237	135 x 110	105 x 75/80	11	350
Swivel castors with locks Elastic solid rubber blue-grey	71262	125 x 40	165	105 x 80	80/76 x 60	9	200
	71263	160 x 50	196	135 x 110	105 x 75/80	11	300
	71264	200 x 50	237	135 x 110	105 x 75/80	11	350
Fixed-wheel castors Elastic solid rubber blue-grey	71272	125 x 40	165	105 x 80	80/76 x 60	9	200
	71273	160 x 50	196	135 x 110	105 x 75/80	11	300
	71274	200 x 50	237	135 x 110	105 x 75/80	11	350



Swivel castors

71302 | 71303 | 71304

Casings made of steel sheet, galvanized. Wheels with polyurethane tyres, alu-rims, hubs with roller bearings. Smooth, silent running, resisting to many aggressive media, long durability.



71302 | 71303 | 71304



71502 | 71503 | 71504

Swivel castors with wheel locks "Double stop"

71312 | 71313 | 71314

Casings made of steel sheet, galvanized. Wheels like swivel castors.



71312 | 71313 | 71314



71512 | 71513 | 71514

Fixed-wheel castors

71322 | 71323 | 71324

Casings made of steel sheet, galvanized. Wheels like swivel castors



71322 | 71323 | 71324



71522 | 71523 | 71524

Swivel castors

71502 | 71503 | 71504

Casings made of steel sheet, galvanized. Polyamide wheels, hubs with roller bearings. Largely resisting to humidity, salt, acids and caustic solutions. Heat-resistant from -40° to +90° C.

Swivel castors with wheel locks "Double stop"

71512 | 71513 | 71514

Casings made of steel sheet, galvanized. Wheels like swivel castors.

Fixed-wheel castors

71522 | 71523 | 71524

Casings made of steel sheet, galvanized. Wheels like swivel castors.

	Order no.	Size of wheel mm	Effective height mm	Plate size mm	Hole centres mm	Bolt hole mm Ø	Capacity kg
Swivel castors Polyurethane	71302	125 x 40	165	105 x 80	80/76 x 60	9	200
	71303	160 x 50	196	135 x 110	105 x 75/80	11	350
	71304	200 x 50	237	135 x 110	105 x 75/80	11	350
Swivel castors with locks Polyurethane	71312	125 x 40	165	105 x 80	80/76 x 60	9	200
	71313	160 x 50	196	135 x 110	105 x 75/80	11	350
	71314	200 x 50	237	135 x 110	105 x 75/80	11	350
Fixed-wheel castors Polyurethane	71322	125 x 40	165	105 x 80	80/76 x 60	9	200
	71323	160 x 50	196	135 x 110	105 x 75/80	11	350
	71324	200 x 50	237	135 x 110	105 x 75/80	11	350

	Order no.	Size of wheel mm	Effective height mm	Plate size mm	Hole centres mm	Bolt hole mm Ø	Capacity kg
Swivel castors Polyamide	71502	125 x 38	165	105 x 80	80/76 x 60	9	200
	71503	150 x 40	191	135 x 110	105 x 75/80	11	350
	71504	200 x 50	237	135 x 110	105 x 75/80	11	350
Swivel castors with locks Polyamide	71512	125 x 38	165	105 x 80	80/76 x 60	9	200
	71513	150 x 40	191	135 x 110	105 x 75/80	11	350
	71514	200 x 50	237	135 x 110	105 x 75/80	11	350
Fixed-wheel castors Polyamide	71522	125 x 38	165	105 x 80	80/76 x 60	9	200
	71523	150 x 40	191	135 x 110	105 x 75/80	11	350
	71524	200 x 50	237	135 x 110	105 x 75/80	11	350



Collapsible hinge

For open carts (one sided):

2500 | 2501 | 2502 | 2503 | 9500 | 9501 | 9502 | 9503

Panelled end platform carts (one sided):

2510 | 2511 | 2512 | 2513 | 1510 | 1511 | 1512 | 1513

Double open-side platform carts (both sided):

2520 | 2521 | 2522 | 2523 | 1520 | 1521 | 1522 | 1523

Automatic push handle interlock, release by foot control.

German patent 10 2010 052 491

Add-on kit per trolley.

Order no.	1273	one sided
Order no.	1275	both sided



1273



Dead man brake

Compact and light wheel lock instead of the swivel castors with wheel lock. For all trolleys with 2 fixed-wheel castors and standard TPE tyres up to 600 kg capacity.

Actuation bar at push handle released = brake tightened, cart is safed against rolling away reliable.

Actuation bar pushed = brake released, cart can be moved easily.

Ergonomic and smooth operation.

Safe braking effect due to form-fitting disabling dovetailing.

Not usable as driving brake.

Surcharge per trolley. Can not be retrofitted.

Order no.	1280
-----------	------

1280



Electric drive unit

As add-on kit for all open carts, panelled end platform carts, box carts, table top carts, shelved trolleys etc. with a wheel-Ø of 200 mm and width from 500 mm. Drive complete with batteries and charging device. Compact unit, easily to be assembled. Operating switch to be clamped to pushbar, connection with plug-in helix cable. Speed fully adjustable, for forward and reverse gears.

Technical specifications: Drive unit: 24 V DC, 2 PM motors: 2 x 12 V, 250 W, 0,7 HP, 2 GEL batteries: 2 x 12 V, 33 Ah, maintenance free. Max. speed 4,8 km/h, with fully charged batteries on a flat surface and a load of 500 kg, max. range: approx. 15 km. Hill climbing ability with 500 kg load: 5%/2°, Elasticated solid-rubber tyres 200 x 50 mm, blue-grey, trackless.

Warranty: 12 months. Surcharge per trolley. Can not be retrofitted.

Order no.	Capacity kg	Net weight kg
2200	500	55

2200



TOTALSTOP-central brake system

Wheel and directional locking devices can be activated with only one push by foot. Apart from the rotation of the wheels, also the swivelling movement of both swivel castors is securely locked.

European patent EP 2743097

See details on page 5. Surcharge per trolley.

Order no.	2210
-----------	------



2210



Wheels with pneumatic tyres
220 x 70 mm, capacity 400 kg. Smooth running on rough surfaces, esp. outdoors. **Available for trolley width from 600 mm.**

No TOTALSTOP possible.

Surcharge on standard wheel set per trolley.

Wheel-Ø	Order no.
125	1098
160	1099
200	1100



Wheels with blue-grey elastic tyres and ball bearing
Non-marking (trackless).
Wheels with elastic tyres and ball bearing. Easy, smooth running, high durability.

Surcharge on standard wheel set per trolley.

Wheel-Ø	Order no.
125	12855
160	12865
200	12875



Wheels with polyurethane tyres
Hubs with roller bearings, smooth, silent running, resisting to many aggressive media.

Surcharge on standard wheel set per trolley.

Wheel-Ø	Order no.
125	2179
160	2180
200	2181



Wheels electrically conductive (anti-static) with TPE ESD tyres (thermoplastic elastomer)
Hubs with precision deep groove ball bearing
Non-marking (trackless).

Surcharge on standard wheel set per trolley.

Wheel-Ø	Order no.
125	2182
160	2183
200	2184



Polyamide wheels
High carrying-capacity. Smooth running on even floors. Largely resisting to humidity, salt, acids and caustic solutions.

Surcharge on standard wheel set per trolley.

Wheel-Ø	Order no.
125	1295
160	1296
200	1286



Directional locking device
Instead of the standard 2 fixed wheel castors, 2 swivel castors with 4 x 90° locking.
Details see page 9.

Surcharge per trolley ONLY on standard TPE-tyres.

Order no.	
23989	



FIXSTOP-central directional locking
Instead of the 2 standard fixed-wheel castors. With only one push by foot both directional lockings are operated.
Details see page 9.

Surcharge per trolley ONLY on standard TPE-tyres.

Order no.	
2220	



Protective edge
Of sturdy foam rubber for perimeter of base frame.

Surcharge per trolley.

Order no.	
1289	



Protective wheels
50 mm Ø made of light grey plastic
total width = platform + 80 mm

Surcharge per trolley.

Order no.	
1299	

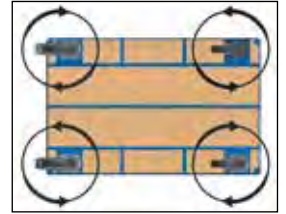

4 swivel castors
Instead of 2 swivel castors and 2 fixed-wheel castors, high manoeuvrability, easily steerable into all directions, limited directional stability.

Surcharge per trolley.

Order no.	
1288	



Platform of rigid PVC panel
Weatherproof rigid PVC panel in dark grey. High chemical resistance, low flammability.

Surcharge per standard platform size.

Platform mm	Order no.
850 x 500	1430
1000 x 600	1431
1000 x 700	1432
1200 x 800	1433



Waterproof platforms
For MultiVario-transporters with with nonslip plywood-board.

Surcharge per standard platform size.

Platform mm	Order no.
850 x 500	1400
1000 x 600	1401
1000 x 700	1402
1200 x 800	1403



Platform with scoring rubber
Platform with glued-on fine rubber. Slip-resistant.

Surcharge per standard platform size.

Platform mm	Order no.
850 x 500	1410
1000 x 600	1411
1000 x 700	1412
1200 x 800	1413



Scanner holder

Powder coated in RAL 7035, with adjustable bolt-on points. Tubular strut with multiple holes, with clamping bracket for attaching the scanner bag onto almost all of our products. Scanner intake W x D x H: 120 x 87 x 150 mm Front opening: 40 mm wide.

Order no. 1392



Tablet holder

Steel sheet galvanised. Delivery incl. adapter for mounting at MultiVario trolleys. Tablets or Smartphones fixed by eccentric levers.

Clamping area W x H x D: 200 x 15-295 x 14 mm

Further details on page 87.

Order no. 28TH



Clip board upright

For upright format DIN A4. Wood with paper clamp and pencil case.

Order no	Format
1290	DIN A4 upright



Clip board broadsize

For broadsize format DIN A4. Wood with paper clamp and pencil case.

Order no	Format
1390	DIN A4 broadsize



Storage tray

Mounting kit for trolleys. Steel sheet powder coated in RAL 7035. Various possibilities of positioning. Simple self assembly with plastic clips. Usable area 496 x 322 x 14 mm

Order no 1381



Shaft and tow hitch

For all MultiVario-transporters (capacity 600 kg - order no. 12920) and Super-MultiVario-transporters (capacity 1200 kg order no. 12921).

Construction as order no. 22894 on page 129.

Version	Order no.
MultiVario	12920
Super-MultiVario	12921



Softgrip

Push handle covered with plastic hose. Slip proof, isolating, pressure relieving and skinfriendly, only for push handle in all widths.

Order no. 1274



Wire basket

For small items, powder coated alu-silver.

L x D x H: 600 x 140 x 200 mm.

Order no. 1291



Push handle screwable - height adjustable

Mounting kit for MultiVario table top carts. tubular steel, powder coated brilliant blue RAL 5007. Simple self assembly with plastic clips, also retro-fittable. Height adjustable for the optimal ergonomic grip position.

Width mm	Order no.
500	E2400SBV
600	E2401SBV
700	E2402SBV
800	E2403SBV



Paper roll holder

mounting kit for trolleys. Suitable for paper rolls up to 210 mm in diameter and 210 mm in width.

For retrofitting purchase, please name the order number of the cart.

Order no. 1396



Bottle holder

For commercial drink bottles and cans 0,33 L to 1,5 L content. Tube strut perforated many times, can be positioned as required with a clamp for fastening the holder.

Order no. 1391



Waste collector

Waste collector with clamp for tube-Ø 27 mm. Powder coated blue RAL 5007. PVC lid and clamping ring, aperture Ø 340 mm. Suitable for 120 litre rubbish bags.

Order no. 1397

SPARE PARTS



Handle
With safety loop for tube Ø 27 mm and Ø 33,5 mm.
European registered design 001240097-0001

for tube Ø 27 mm:
Order no. 1762

for tube Ø 33,5 mm:
Order no. 1763



Plastic skids
1 set with clips.

Order no. 1753

ESD-SPARE PARTS



ESD-Handle
With safety loop for tube Ø 27 mm.
Electrically conductive.
European registered design 001240097-0001

for tube Ø 27 mm:
Order no. 1764



ESD-Plastic skids
1 set with clips.
Electrically conductive.

Order no. 1754



Clamping band
Two-pieced clamping band for all trucks.

Order no. 1722G

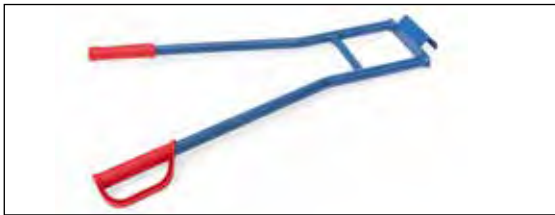

Carrier spars
For all trucks except 11050, 11051 and 11052. 2 handholds with clamps and wide cross strut, welded, powder coated blue RAL 5007.

Order no.	Capacity kg	Height mm	Width mm
11045	350	850	570



Wheel spider lock
Add-on kit for stairway trucks TK1325, TK1326, AK1325 and AK1326. Wheel spider lock for easy moving on 2 wheels on flat surface. Easy self assembly.

Order no. 1770



Punctureproof tyres
Made of polyurethan material, absolutely punctureproof. Driving comfort similar to pneumatic wheels. Suitable for all trucks and trolleys with pneumatic wheels.

Surcharge per trolley.

Wheel mm	Order no.	Capacity kg per wheel	Packing unit
260 x 85	1776	150	pair = 2 pieces
260 x 85	1777	150	set = 4 pieces
400 x 100	1778	250	pair = 2 pieces
400 x 100	1779	250	set = 4 pieces

A		E		Open carts	12, 31, 65, 105	Steps	84-85
Accessories	84-87, 110, 112, 128-129, 183-186	Electric drive unit	183	Open carts with sheet steel platform	31	Storage boxes	100, 112
Accessories for MultiVario- Transporters	84-87, 110, 112, 128-129, 183-186	ESD-dollies with gooseneck handle	65	Open sided platform carts	32-33	Storage tray	41, 185
Accessories for pallet dollies	17, 128-129	ESD-euro box carts	71	Optiliner	29	Storage trolleys	71, 96-98
Accessories for trucks	186	ESD-euro box rollers	70	Optiliner table top carts	29	Storeroom trolleys	11, 24, 83-88
Additional shelves	19, 55-58, 68, 80-81, 84-85, 99, 107	ESD-mobile tilting stand	69	Outdoor hand carts	134	Subdivision-set	15, 36-46, 50, 106
Add-on kit hand carts	134	ESD-open carts	65			Super-MultiVario-Transporters	13, 105-107
Add-on kit table top carts	36-46, 106	ESD-pallet dollies	69	P		Swivel castors	179-182, 184
All-steel trolleys	26	ESD-reinforcement struts	68	Pallet dollies	16-17, 69, 127-131		
Aluminium platform trolley	26	ESD-shelved trolleys	68	Pallet dollies as tugger train	130	T	
Aluminium trucks	144-145, 147	ESD-storage trolleys	70	Pallet dollies for standard tugger trains	16, 131	Table top carts	13-14, 25, 36-41, 66-67, 106, 159
Angle rolls	177	ESD-table top carts	66-67	Pallet feet	117	Table tops	46
Anti-skidding device	109	ESD-trolleys	65-71	Pallet trucks	169-171	Tablet holder	87, 185
Assembly trolleys	99	ESD-tubular steel trucks	65	Panelled end platform carts	32-33, 106	Thorn bracket	112
Attachable platform	171	Euro box carts	18, 71, 93-95	Parcel carts	60-61, 151	Tipping containers	125
		Euro box rollers	18, 70, 90-91	Parcel carts with roof	61	Tool box	160
		Euro boxes	100	Plastic platform trolley	26	TOTALSTOP-central brake system	8, 183
B				Plastic skids	143, 145, 186	Tow coupling	133-134
Bale cradle dolly	23	F		Platform carts	25, 31, 105	Tow hitch	84-85, 129-130, 133-134, 137-138, 185
Bale trolleys	34	Fixed wheels	179-182	Platform trolleys	12, 31, 65, 105	TPE tyres	8, 180
Bicycle coupling	133-134	FIXSTOP-central directional lock	9, 184	Polyamide wheels	182, 184	TPE-ESD tyres	180, 184
Blotting pad	51	Forked bracket	112	Protective edge	184	Traction eye	137-138
Bottle holder	86, 185	Furniture lifting rollers	177	Protective wheels	184	Transport rollers	174
Box carts	19, 34, 69, 78-81	G		PU wheels	179, 186	Trolleys for long goods	120
Boxes for shelved trolleys	57	Galvanised carts	83-87, 133-134	Push handle	129, 185	Trolleys for sheet material	116-118
		GREY EDITION	12-20			Trolleys with carrier spars	109-110
		Guide roller	84-85	R		Trucks for appliances	153-154
C				Reinforcement struts	19, 55-57	Tubular bracket	112
Cable drum	45	H		Reinforcement struts ESD	68	Tubular steel trucks	140-143, 146, 150-153
Carrier spar	110	Hand carts	133-135	Roller conveyor with attachable frame	173	Tubular supports	129
Carts for sheet material	115	Hand trucks	137-138	Roller conveyor with live ring	173	Tugger trains	130-131
Carts with trays	13, 38-39, 67, 159	Hand winch stacker	172	Roller cupboards	50	TYRE TROLLEY	165, 167
Cash and carry carts	53	Handle	142-147, 168	Roller supports	103	Tyre trucks	166
Castor wheels	179-182, 184	Handle for lateral shifting	85	Rolling desks	48-50		
Castor wheels with lock	179-182, 184	Heavy carts	14, 105-107	Rolling tables	51	U	
Chair trucks	152	Heavy table top carts	106			Unplasticised PVC board	184
Clamping band	150, 153, 186	Heavy workshop carts	46	S			
Clip board	41, 53, 86, 185	High lift pallet truck	171	Safety chain	122, 124-125	W	
Closed platform carts	32-33	Holding horns	150	Scanner holder	13-14, 36-40, 86-88, 185	Wall mounting	163
Collapsible carts alu	28	Hydraulic hand stacker	172	Scoring rubber platform	184	Wall securing chain	53
Collapsible carts steel	12, 26-29			Screwable back wall	85	Waste collectors	159, 185
Collapsible hinge	183	I		Self-locking push handle	17, 129	Waterproof platform	184
Compact hand trucks	149-150	Identification board	86	Self-tilting boxes	124	Wheel specification	10, 178-184
Corrugated bracket	112	Insertable shaft	90	Separating grid	84-85	Wheel spider lock	146-147, 186
Coupling	84-85, 129-130, 133-134, 137-138, 185	Insertable tubular support	129	Set of wheels	124-125	Wheel with solid rubber	178, 184
Cover for boxes	100	L		Shaft	84-85, 129-130, 185	Wheels	178-182
Cover for sheet metal dump trucks	123	Lever handle	158	Sheet material stands	117	Wheels with blue-grey solid rubber tyres	181, 184
		Lifting rolls	177	Sheet material trolleys	116-118	Wheels with electrically conductive tyres	180, 184
D		Lifting table carts	173	Sheet metal dump trucks	122	Wheels with pneumatic tyres	73-76, 179, 184
Dead man break	183	Light table top carts	13, 25, 39-41, 66	Sheet steel box carts	79, 81	Wheels with polyurethane tyres	179, 182, 184
Deposit locks	53	Light workshop carts	44-45	Sheet steel box carts with cover	79	Wing Door	85
Directional locking device	9, 131, 184	M		Shelved trolleys	19, 55-58, 63, 68, 107	Wire basket	51-52, 185
Document box	87	Machine lifter	174	Shelved trolleys with detachable shelves	63	Wire cage carts	19, 69, 78, 80
Dollies	23	Material box	112	Shelves	19, 55-58, 68, 80-81, 84-85, 99, 107	Wooden box carts	34, 78
Dollies for furniture	178	Material tub	112	Side frame carts	34	Workpiece trolleys	112
Dollies for sheet	114	Mobile drum cradles	158	Skid lifter	171	Workshop carts	15, 43-46
Dollies with gooseneck handles	12, 22, 65	Mobile tilting stands	18, 69, 102-103	Softgrip	185	"Wuppi"	150
Double open-side platform carts	32-33	Modules for trolleys with carrier spars	110	Stackers	172		
Drainage tap	122-125	Moving gears	176	Stacking frames for pallet dollies	17, 128		
Drawer add-on kit	36, 44-46, 106	MultiVario-Transporters	6-7, 12, 14, 31-38	Stainless steel trolleys	76		
Drawer subdivision-set	15, 36-46, 50, 106			Stairway trucks	146-147, 154, 162		
Drum cradles	158	N		Stanchioned trolleys	29, 105		
Drum dollies	156	Nesting trolleys	53	Steel bottle dollies	162		
Drum for compressed air hose	45	Notebook holder	87	Steel bottle stairway truck	146		
Drum trolleys	157	O		Steel bottle stand	163		
		Office trolleys	73-74	Steel bottle trolleys	160-161		
		Oil drain pan	158	Steel sheet workshop carts	15, 43		

T not included / We reserve the right to make technical alterations.
rights reserved. This catalogue, or parts thereof, may not be reproduced without prior permission of publishers.
photographs are protected by § 72, Copyright Act.
avoid transport damages, we reserve the right of a pre-assembled delivery.

bwz[®]  **Schwingungs-
Technik**